

BAUMATERIAL SPÄTH

Bau- und Gartenbedarf

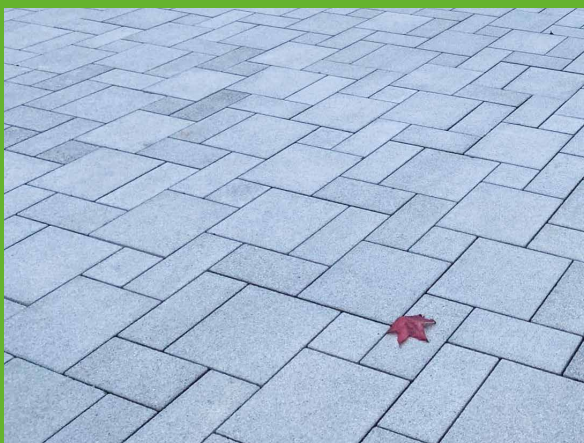

2024



Falkensteinerstrasse 13 • Muttenz
061 641 13 51 • www.spaeth-shop.ch

**Ihre
Ansprechpartner**



Hansjörg Späth

Geschäftsführer, Eigentümer
spaeth@baumaterial-spaeth.ch
Telefon 061 641 13 51
Spezialgebiete: PCI-Produkte,
Betonwaren, Gartenbedarf, Probst

In der Firma seit

1986



Sascha Beccarelli

Verkauf Innendienst
beccarelli@baumaterial-spaeth.ch
Telefon 061 577 29 90
Spezialgebiete: Bauprodukte, Zäune,
Terrassenholz, Bewässerung

2012



Albina Kläui

Verkauf Innendienst
klaeui@baumaterial-spaeth.ch
Telefon 061 577 29 94
Spezialgebiete: Feinsteinzeugplatten,
Plattenlegerprodukte, Arbeitskleidung

2014



Mario Wermuth

Verkauf Aussendienst
wermuth@baumaterial-spaeth.ch
Telefon 079 199 30 81
Spezialgebiete:
Hoch-/Tiefbau, Gartenbau, Betonwaren

2018



Claudia Beccarelli

Verkauf Innendienst / Shop
claudia.beccarelli@baumaterial-spaeth.ch
Telefon 061 577 29 99
Spezialgebiete:
Gartenbau, Gardena, Werkzeug

2019

Sandra Schär

Shop
Telefon 061 641 13 51

2022

Karin Stocker

Buchhaltung
buchhaltung@baumaterial-spaeth.ch
Telefon 061 641 13 51

2016

1 Gartenbedarf Platten, Verbundsteine & Zubehör 5

Neu: Betondielen Holzstruktur 17
Schellevis-Platten 18
Feinsteinzeug Gaja 20, Atmos 20, Interiorstone 20..... 21-24
Rustico-Pflaster polygonal 53
Kleinpflaster getrommelt 53
Pflasterklinker..... 57
L-TEC Winkelplatten Light..... 73

Gartenbedarf allgemein 77

Neu: Sytecdrain Drainagematte..... 41
Giessring 116
OHS Rollrasen franko geliefert..... 111
Faltzelte Profi..... 121

2 Baumaterialien 123

Neu: Weber Beton 916 frost-tausalzbeständig..... 125
PCI Polycrret 50..... 129
PCI Polycrret Multi 129
Barraseal Ready..... 130
Sika Swell S2..... 137
Profile Edelstahl gebürstet..... 139
Soba Ablaufschächte 168

3 Bedachungsmaterial 178

4 Holz & Isolationen 183

5 Betriebs- und Verbrauchsmaterial 191

Neu: Ladeschienen..... 199

Dienstleistungen & Infos/Index 204

= Versickerungsleistung = CH-Produktion

**Fachberater
unserer
Partnerfirmen**

Aco Passavant, Rinnen+Bauguss	Roman auf der Maur	079 849 03 48
Creabeton AG	Patric Ehresheim	079 217 65 56
Cermix Schweiz	Hanspeter Lysser	079 757 21 25
Dörken AG	Bernhard Wyss	078 600 03 10
Eric Schweizer AG	Manuel Weber	079 608 40 30
FLN, Landolt, Geotextilien	Roger Tresch	079 824 60 04
Gutjahr	Peter von Flüe	079 337 52 01
Mapei Bauprodukte	Roger Mohler	079 176 31 13
Mapei Plättliprodukte	Michel Herzog	079 335 96 41
Maxit (Beton+Mörtel)	Bernhard Leisinger	079 645 38 42
OHS (Rasen)	Philipp Sax	079 331 91 15
PCI Bauprodukte	Dominique Dittli	079 828 58 31
PCI Plattenlegerprodukte	Enrico Bizzotto	079 216 15 53
Ricoter Erden	Florian Hürbin	079 357 99 05
Swisspor	Roland Wächter	079 276 67 09
Sytec AG	Patric Gobetti	079 611 64 74
Tschümperlin AG	Michel Jungo	079 215 77 82
Velux Schweiz AG	Adrian Jeker	079 953 98 60

Telefon 061 641 13 51



Qualitätswerkzeuge für Profis

Steinemann AG
Wilerstrasse 218
CH-9230 Flawil / SG
Tel. +41 71 394 14 14
Fax +41 71 394 14 43
info@steinemanngroup.com

EINFACH. MEHR. BAU.

Gartenbedarf



BAUMATERIAL SP'ATH
Bau- und Gartenbedarf

CERMIJOINT RUSTIC FÜR DICKE PLATTEN UND NATURSTEINE

alle Preise exkl. MwSt



CERMIJOINT RUSTIC GM / GK

Fugenmörtel für breite Fugen
von 3 bis 20 / 5 bis 50 mm

GM



ERDFARBE GOLD



ERDFARBE HELL



ERDFARBE ROSA



ERDFARBE GRAU



ERDFARBE OCCITANE



ERDFARBE ASCHGRAU



ERDFARBE DUNKEL



GK



BURGUNDERSTEIN



STEIN GRAU



PROVENCESTEIN



EUVILLESTEIN



1.1 Gartenplatten

1.1.1 Zementplatten grau, glatt

ca. 95 kg/m²

Grössen in cm

Grössen in cm	4,2 cm stark, gefast ^(D)		4,0 cm stark, Minifase ⁽⁺⁾	
	m ² /Palette	CHF/m ²	m ² /Pal.	CHF/m ²
50 x 50	9,0	26.50	12,00	29.00
50 x 25		–	9,00	33.00
40 x 40	9,12	26.50	11,52	29.00
60 x 40	9,12	26.50	11,52	29.00



1.1.2 Grauplatten gefast ^(D)

mit integrierten Abstandhaltern, 5 cm stark

Grössen in cm	kg /m ²	m ² /Pal	CHF/m ²
40 x 40	115	7,68	28.00
50 x 50	115	12,00	28.00
60 x 40	115	7,68	28.00



1.1.3 Gehwegplatten «Parco Selection» gefast, glatt grau, ⁽⁺⁾ hydrophobiert (nur auf Bestellung)

Grössen in cm	kg /m ²	m ² /Pal	CHF/m ²
40 x 40 x 3	68	18.24	42.00
40 x 40 x 4	90	14,4	38.40
50 x 25 x 4	90	15,0	43.20
50 x 50 x 4	90	15,0	37.70
60 x 40 x 4	90	14,4	39.50



1.1.4 Zementplatten, grau, vollkantig, ^(D)

Grössen in cm	kg /m ²	m ² /Pal	CHF/m ²
50 x 50 x 4,5	120	12,00	31.00
40 x 40 x 4,5		11,52	31.00
60 x 40 x 4,5		11,52	31.00
30 x 30 x 4		13,68	33.00



1.1.5 Waschbetonplatten Rheinkies, Korn 4–8 mm, 4,1 cm, grau, ^(F)

Grössen in cm	kg /m ²	m ² /Pal	CHF/m ²
50 x 50	96	9	32.00
40 x 40		17,28	32.00





Korn 8–16 mm, 4,5 cm, grau ^(D)

Grössen in cm	kg /m ²	m ² /Pal	CHF/m ²
50 x 50 (49,5 x 49,5)	104	17,00	34.00
40 x 40 (39,5 x 39,5)		16,32	34.00
40 x 60 (39,5 x 59,5)		16,32	34.00





SCHWEIZER HERSTELLER VON
HOCH TECHNISCHEN PRODUKTEN FÜR BAUPROFIS
www.cermix.ch

alle Preise exkl. MwSt



1.1.6 Platten Bondeno, grau, gefast, leicht gestrahlt, 				
Grössen in cm	kg/m ²	m ² /Palette	CHF/m ²	
50 x 50 x 4,2	97	9,0	33.00	
40 x 40 x 4,2	97	8,64	33.00	
40 x 60 x 4,2	97	8,64	33.00	
30 x 60 x 4,2	97	6,48	39.00	
60 x 60 x 4,2	97	12,96	39.00	
80 x 40 x 4,2	97	8,34	39.00	

Finalgo-Vakuu-Platten teils ab Lager!

-> siehe Preisliste Creabeton (www.baumaterial-spaeth.ch)

1.1.7 Zementplatten leicht sandgestrahlt, fein gefast				
Grössen in cm	kg/m ²	 Masso Vakuu, grau leicht gestrahlt CHF/m ²	 Masso Vakuu, farbig leicht gestrahlt CHF/m ²	 gegossen grau leicht gestrahlt CHF/m ²
50 x 50 x 4	90	44.00	50.00	42.30
50 x 25 x 4	90	50.00	56.00	53.20
50 x 75 x 4 / 50 x 100 x 4 oder 5	90/108	55.50	61.50	86.00
100 x 100 x 5 / 120 x 120 x 5	108	-	-	87.00
40 x 40 x 4	90	50.00	56.00	42.30
40 x 60 x 4	90	46.00	52.00	42.30
50 x 50 x 3 / 40 x 40 x 3	75	50.00	54.00	43.00



1.1.8 Sandgestrahlte Platten Korn 0 – 16 mm			
Grössen in cm	Stk/Pal	 sandgestrahlt-grau CHF/m ²	 sandgestrahlt farbig CHF/m ²
50 x 50 x 3,6	20	50.00	64.00
50 x 25 x 3,6 / 60 x 30 x 3,6 * / 50 x 30 x 3,6 *	40	56.00	68.00
50 x 75 x 4 / 50x100x4 / 60x100x4	20	86.00	97.00
60 x 100 x 5 / 100 x 100 x 5	20/8	87.00	98.00
40 x 40 x 3,6 / 40 x 50 x 3,6*	20	50.00	64.00
40 x 60 x 3,6 / 60 x 60 x 3,6 *	20	50.00	64.00

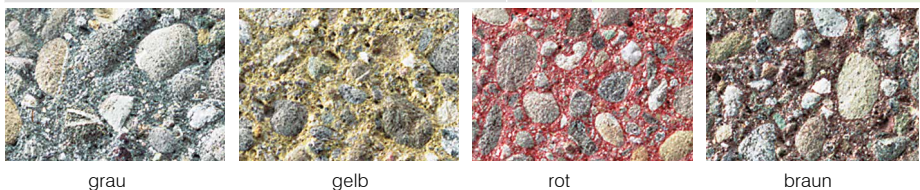



alle Preise exkl. MwSt

1.1.9 Rundplatten gegossen neu , vibriert, unarmiert leicht kugelgestrahlt, Farben: zementgrau, braun, rot, gelb, schwarz * auch grob gestrahlt erhältlich		
Ø in cm	* zementgrau CHF/Stk	eingefärbt CHF/Stk
45, 50 oder 55 cm	23.00	27.50
70 cm	62.00	68.00

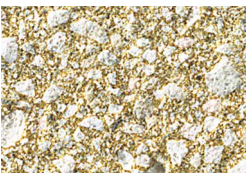

1.1.10 Spezial-Platten sandgestrahlt Masso		 Masso V-Jurasplitt gelb, sandgestrahlt	
Grössen in cm	CHF/m ²		
50x50 / 40x60 *	60.00		
40x40 / 60x60 / 50x25 / 50x75 / 50x100 *	63.00		

* nur auf Bestellung

1.1.11 Platten «Grès de Vosges» 		m ² /Palette	kg/m ²	CHF/m ²	
wassergestrahlt, gefast mit Sandsteinstruktur					
40 x 40 x 4,1 cm	17,28	96	50.00		
50 x 50 x 4,1 cm	9,00	96	50.00		

1.1.12 Arcadia Platten, kugelgestrahlte Oberfläche mit Fase, Dicke: 4,2 cm, Gewicht: 97 kg/m ²					
Farbe	Format	m ² /Pal	Stk/m ²	Stk/Pal	CHF/m ²
granitweiss, granithell, beige, dunkelgrau	40 x 40 cm	8,64	6,25	54	49.50
	50 x 50 cm	9,00	4	36	49.50
	60 x 40 cm	8,64	4,17	36	49.50



Hinweis
Sämtliche Gartenplatten sollten niemals pressverlegt werden. Es sollte mindestens 1 mm Fugenabstand eingehalten werden; besser noch, die Platten mit Abstandhaltern verlegen.

**making
hard work
easier**



Winkелеlementzange WEZ-06

Mauerscheiben sicher & gerade setzen.
 ■ Tragfähigkeit bis 600 kg ■ Nur 14 kg Eigengewicht

Seit 60 Jahren machen unsere Werkzeuge und Maschinen den Baustellenalltag leichter. Heute sind wir Weltmarktführer und definieren das Baustoff-Handling auf Baustellen und in Betonwerken.

Probst-Produkte für die unterschiedlichsten Einsatzzwecke im Garten- und Landschaftsbau:



EASYGRIP EXG
Rabattengreifer



EASYCLEAN EC-60
Pflasterreinigungsggerät



STONE SPLITTER STS-EASY
Platten- und Verbundsteintrenner



STEINMAGNET SM-GREENLINE
Vakuum-Anbaugerät



SZ
Steinzieher



EASYPLAN EP-UNI
Handabziehsystem

Technische Änderungen, die dem Fortschritt dienen, vorbehalten.
 Abbildungen beispielhaft und nicht verbindlich.

www.probst-handling.de

alle Preise exkl. MwSt

1.2 Platten mit Oberflächenschutz

1.2.1 Garten-/Terrassenplatten BMS PREIS-HIT!

Kugelgestrahlt, gefast und Premium imprägniert, 4,2 cm stark



	Farbe	Format cm	m ² / Palette	kg/ m ²	CHF/m ²
BMS 01 (Nova 01)	hellgrau	60x40, 40x40	16,32	96	43.00
		80x40	8,32		47.00
BMS 11 (Nova 11)	anthrazit	60x40, 40x40	16,32	96	43.00
		80x40	8,32		47.00
BMS 152 (Madrid)	juragelb	60x40, 40x40	16,32	96	55.00
		80x40	8,32		58.00
BMS 154 (Granada)	weiss	60x40, 40x40	16,32	96	55.00
BMS 156 (Barcelona)	herbstbraun	60x40, 40x40	16,32	96	55.00

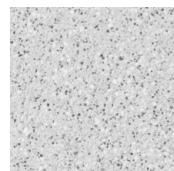

BMS 01

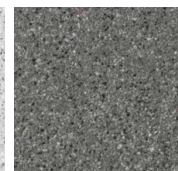

BMS 11



BMS 152



BMS 154



BMS 156



BMS 152



BMS 156

1.2.2 Garten-/Terrassenplatten Pasand **PREIS-HIT!** **LITHON**

kugelgestrahlt, mit b.c.s. Oberflächenschutz

Farben	Format	m ² / Palette	kg/ m ²	CHF/m ²
crème, grau, alaskagrau, quarzgrau, (*ohne Oberflächenschutz)	40 x 40 x 4,2 cm	8,0	97	39.50
	40 x 60 x 4,2 cm	8,64	97	39.50
anthrazit, granit-weiss, pigmentgrau, playa-beige, nero, bianco, feingranit, sophistograu**, oysterbeige**, seidengrau, vulkangrau, achatgrau**	40 x 40 x 4,2 cm	8,0	97	47.00
	40 x 60 x 4,2 cm	8,64	97	47.00
	**40 x 80 x 5 cm	7,68	115	50.50



1.2.3 Arcadia Platten CT, kugelgestrahlt mit CleanTop Oberflächenschutz, mit Fase, Dicke: 4,2 cm, Gewicht: 97 kg/m² **Birkenmeier stein+design**

Farbe	Format	m ² /Pal	Stk/m ²	Stk/Pal	CHF/m ²
hellgelb (nur 50x50)	50 x 50 cm	9,00	4,00	36	60.40
granithell, granitweiss,	40 x 40 cm	8,64	6,25	54	60.40
anthrazit/weiss	60 x 40 cm	8,64	4,16	36	60.40

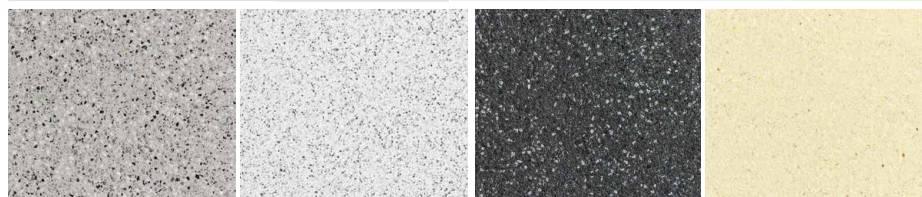

1.2.4 Arcadia Premium Platten CT, feinkörnige, kugelgestrahlte Oberfläche mit CleanTop Oberflächenschutz, mit Fase, Dicke: 4,2 cm, Gewicht: 97 kg/m² **Birkenmeier stein+design**

Farbe	Format	m ² /Pal	Stk/m ²	Stk/Pal	CHF/m ²
hellgrau, dunkelgrau, anthrazit	40 x 40 cm	8,64	6,25	54	71.50
	60 x 40 cm	8,64	4,16	36	71.50
weiss, elfenbein (nur 60x40)					

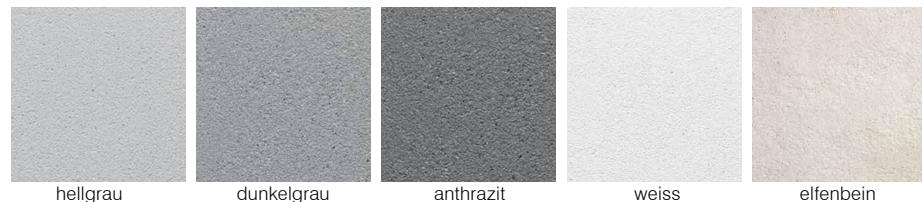

1.2.5 CleanStone Oberfläche beschichtet, besonders leicht zu reinigen, Algen- und Mooshemmend, frei von Kalkausblühungen, geschliffene Fase, hohe Farbbeständigkeit, 4 cm stark, Gewicht: 97 kg/m² **BRAUNBETON**

Farbe	Format	m ² /Pal	Stk/m ²	Stk/Pal	CHF/m ²
sterlinggrau, terra-beige	40 x 40 cm	8,96	6,25	56	80.00
	60 x 40 cm	8,64	4,16	36	80.00
	80 x 40 cm	8,96	3,125	28	80.00
	60 x 60 cm	12,96	2,778	36	84.00



1.2.6 Garten-/Terrassenplatten Fayal strukturiert & kugelgestrahlt (mit b.c.s. Oberflächenschutz) **LITHON**

Farbe	Format cm	m ² /Palette	kg/m ²	CHF/m ²
atlasgrau, graumix, cappuccino	40 x 60 x 4,2	8,64	97	49.00



1.2.7 Garten-/Terrassenplatten Fiamata

diamantgebürstet, gefast und Premium imprägniert, 4,2 cm stark



	Format cm	m ² / Palette	kg/m ²	CHF/m ²
Fiamata 62 - stracciatella	40x40	16.32	96.00	68.00
	60x40	16.32	96.00	68.00
	80x40	8.32	96.00	68.00
	60x60	12.24	96.00	72.00
Fiamata 63 - cappuccino	60x40	16.32	96.00	68.00
	80x40	8.32	96.00	68.00
Fiamata 65 - ardesia	40x40	16.32	96.00	68.00
	60x40	16.32	96.00	68.00
	80x40	8.32	96.00	68.00
	60x60	12.24	96.00	72.00
Fiamata 66 - amaretto	60x40	16.32	96.00	68.00
	80x40	8.32	96.00	68.00
Fiamata 67 - macchiato	40x40	16.32	96.00	68.00
	60x40	16.32	96.00	68.00
	80x40	8.32	96.00	68.00
	60x60	12.24	96.00	72.00
Fiamata 69 - nero	40x40	16.32	96.00	68.00
	60x40	16.32	96.00	68.00
	80x40	8.32	96.00	68.00
	60x60	12.24	96.00	72.00

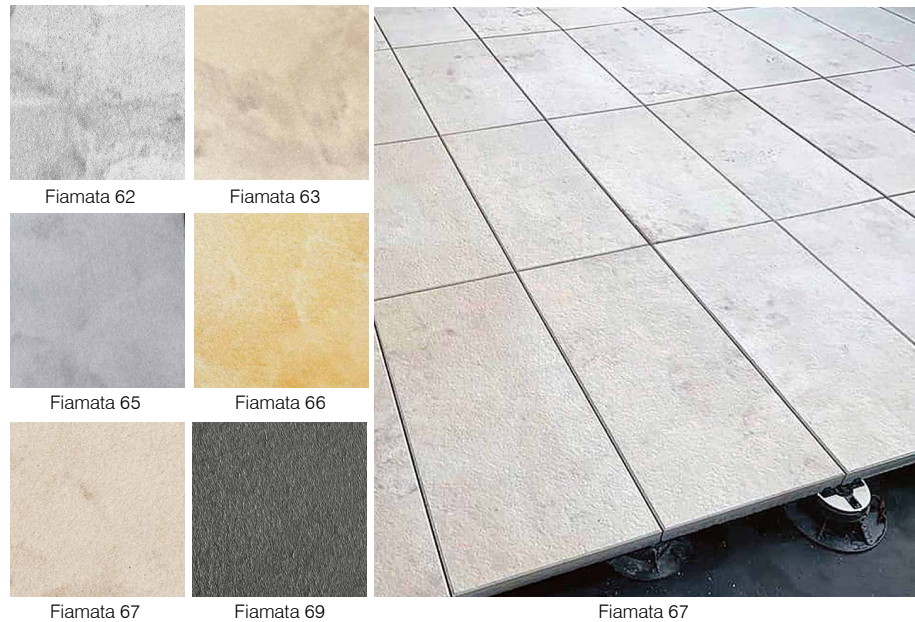

1.2.8 Grossformat-Platten Massimo

Sichtbeton rau mit Oberflächenschutz

Farbe	Ausführung	Format	m ² /Pal	kg/m ²	CHF/m ²
grau	Platte	100x100x5 cm	8,0	115	129.00
		100x50x5 cm	5,0	115	129.00
		100x25x5 cm	3,75	115	134.00
		(Pool-) Randplatte	Format	Stk/Pal	kg/Stk
anthrazit oder platingrau	Platte	100x100x5 cm	8,0	115	146.00
		100x50x5 cm	5,0	115	146.00
		100x25x5 cm	3,75	115	151.00
		(Pool-) Randplatte	Format	Stk/Pal	kg/Stk
anthrazit oder platingrau	Innenecke	100x35x5 cm	10	43	65.50
		50x35x5 cm	10	27,5	112.00
		35x35x5 cm	10	15,1	112.00
		Aussenecke	Format	Stk/Pal	kg/Stk
anthrazit oder platingrau	Trapezplatte	100x30-50x5 cm		48	72.50
		100x35x14 cm	8	120	140.00
		50x35x14 cm	16	60	70.00
		Blockstufe Massimo gegossen Sichtbeton mit Oberflächenschutz	Format	Stk/Pal	kg/Stk

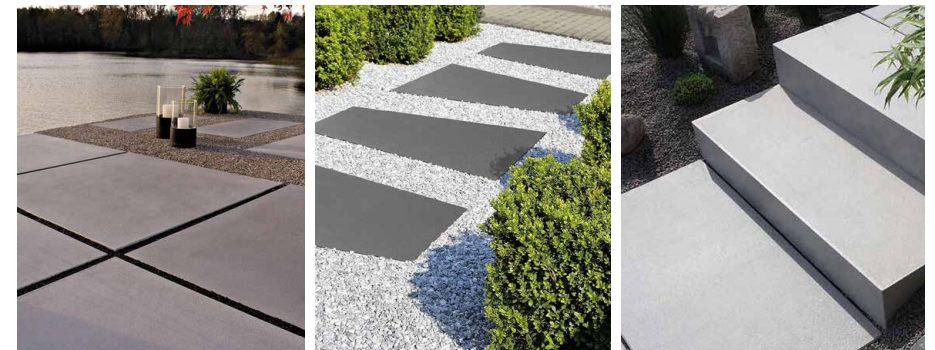
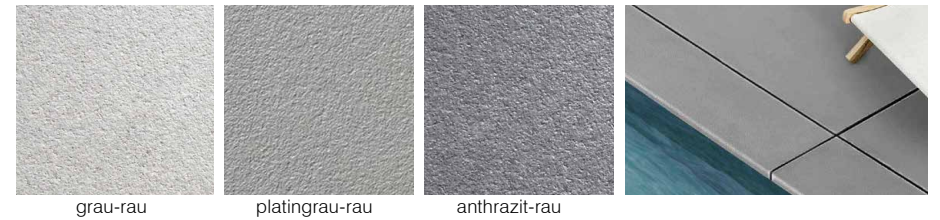
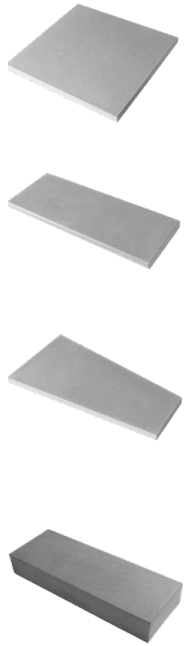

alle Preise exkl. MwSt

1.2.9 Garten-/Terrassenplatten TrendLine

gefast und Premium imprägniert, 4,2 cm stark



	Farbe	Format cm	m ² / Palette	kg/m ²	CHF/m ²
TrendLine 90	lavaschwarz	60x40	16,32	96	63.00
TrendLine 91	silbergrau	80x40	8,32	96	63.00
TrendLine 92	lichtgrau				



TrendLine 90 TrendLine 91 TrendLine 92

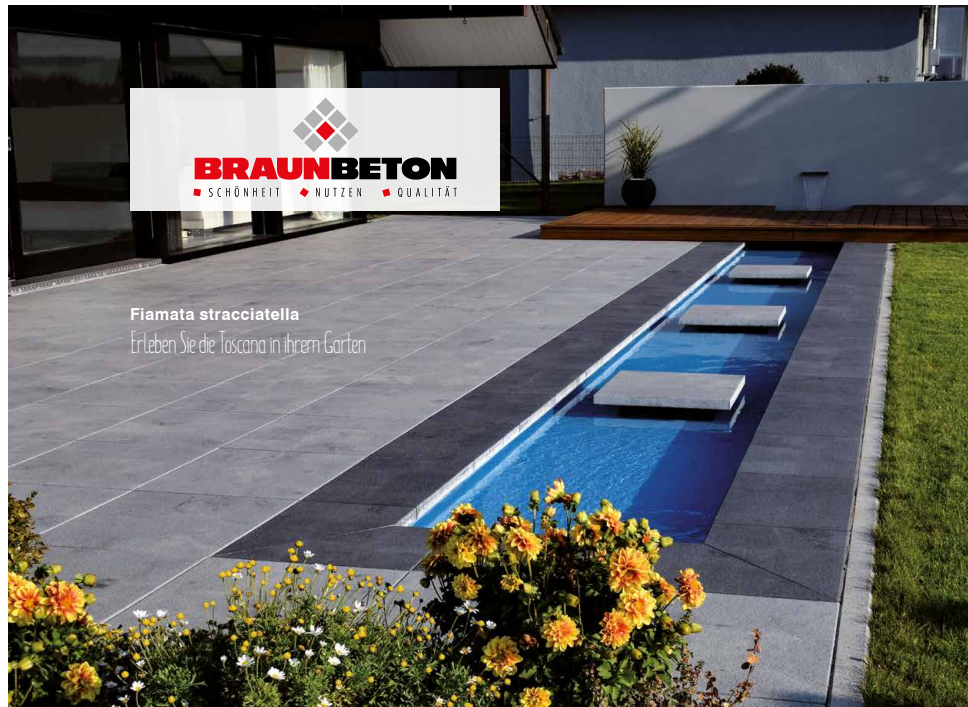

Fiamata stracciatella
Erleben Sie die Toscana in Ihrem Garten

alle Preise exkl. MwSt

1.2.10 Garten-/Terrassenplatten CreativLine

gefast und Premium Beschichtung, 4 cm stark



	Farben	Format cm	m ² / Palette	kg/m ²	CHF/m ²
CreativLine 210	walnussbraun	80x40	8,96	97	89.00
CreativLine 211	teakgrau				
CreativLine 212	felsgrau				
CreativLine 213	cemento-grau				
CreativLine 214	cemento-anthrazit				
CreativLine 215	quarzitgrau				

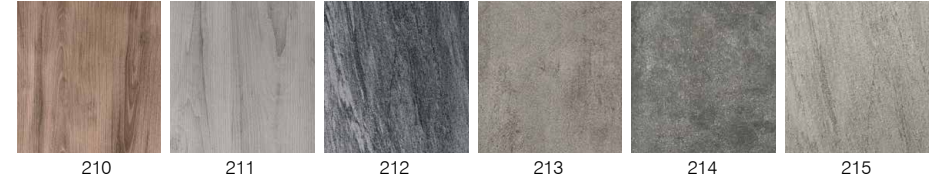

210 211 212 213 214 215



1.2.11 Betondielen «Holz-Look» neu

WetCast-gefertigt, sehr filigrane Struktur, barfuss begehbar

Farbe	Format cm	m ² / Palette	kg/m ²	CHF/m ²
braun, grau, pina	200 x 20 x 5 cm	4,8	120	108.00



braun

grau

pina

1.2.12 Baumscheiben Holzstruktur



Format cm	Stk/pal	kg/Stk	CHF/Stk
Ø 30 - 39	100	ca 8,0	17.00

braun, Dicke: 3,5 cm



1.2.13 Garten-/Terrassenplatten Schellevis

5 cm stark, ca. 100 kg/m²



	Format cm	CHF/m ²
Anthrazit	20x20*, 40x40*, 50x50*, 60x40*, 60x60*	93.50
Carbon	20x20*, 40x40*, 50x50*, 60x40*, 60x60*	99.00
Grau	20x20*, 40x40*, 50x50*, 60x40*, 60x60*	78.00
Crème	20x20*, 50x50, 60x40, 60x60*	78.00
Rotbraun	20x20, 50x50, 60x60	72.00
Taupe	50x50*, 60x60*	72.00

* auch 7 cm stark erhältlich, gegen Aufpreis

7 cm stark	CHF/m ²
Anthrazit 120x60	129.90
Carbon	136.80
Grau	124.30

Grossformate 5 cm stark	CHF/m ²
Anthrazit 80x40, 80x80, 100x100	113.30
Carbon 80x40, 80x80, 100x100	123.15
Grau 80x40, 80x80, 100x100	108.20
Crème 80x80, 100x100	163.00
Rotbraun 80x80, 100x100	123.15
Taupe 80x80, 100x100	123.15

7 cm stark, 224 kg/m ²	CHF/Stk.
Anthrazit 120x120	187.50
Carbon	197.00
Grau	179.00

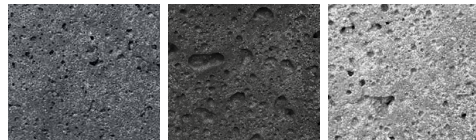

Anthrazit Carbon Grau



Crème Rotbraun Taupe

Andere Grossformate, Bordsteine und Stufen auf Anfrage!

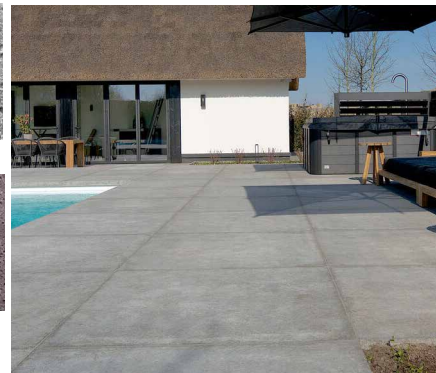

1.3 GeoCeramica - Verbundplatten

Beton-Keramik Verbundplatten für Terrassen & Balkone im privaten Bereich
1 cm Keramik und 3 cm Beton

1.3.1 Evoque neu beige oder greige	kg/m ²	m ² / Palette	CHF/m ²
60 x 60 cm	87	10,8	96.00
80 x 80 cm	87	9,61	119.00



1.3.2 Fumatto Mezzo	kg/m ²	m ² / Palette	CHF/m ²
60 x 60 cm	87	10,8	96.00
80 x 80 cm	87	9,61	119.00



1.3.3 Lava Slate	kg/m ²	m ² / Palette	CHF/m ²
60 x 60 cm	87	10,8	96.00
80 x 80 cm	87	9,61	119.00



1.3.4 Fiordi fumo oder sand	kg/m ²	m ² / Palette	CHF/m ²
60 x 60 cm	87	10,8	96.00
80 x 40 cm	87	9,58	112.00



alle Preise exkl. MwSt

1.3.5 Timber tortera oder noce	kg/ m2	m2/ Palette	CHF/ m2
Format			
80 x 40 cm	87	9,58	112.00



1.3.6 Corten Steel	kg/ m2	m2/ Palette	CHF/ m2
Format			
80 x 80 cm	87	9,61	119.00



1.3.7 Cendre Rock	kg/ m2	m2/ Palette	CHF/ m2
Format			
80 x 80 cm	87	10,8	96.00

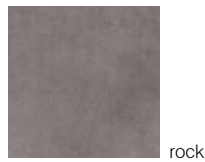

1.3.8 Clocal Classic classic oder chamois	kg/ m2	m2/ Palette	CHF/ m2
Format			
60 x 60 cm	87	10,8	96.00



1.3.9 Clay Design Fancy	kg/ m2	m2/ Palette	CHF/ m2
Format			
60 x 60 cm	87	10,8	96.00



1.4 Feinsteinzeug-Platten für den Aussenbereich

Gemäss neuen CH-Normen dürfen 2 cm starke Feinsteinzeugplatten nur im Mörtel verlegt werden!

1.4.1 Metropolis

2 cm stark, rektifiziert (scharfkantig) mit Betoncharakter



Grösse cm	Gewicht m ²	m ² /Pal.	CHF/m ²
60x60	40,6 kg	24,3	52.00
90x90			74.00
120x60			72.00



1.4.2 Gaja 20 **neu**

2 cm stark, rektifiziert (scharfkantig)

hohe Bruchlast, frostsicher,
Rutschhemmung R 11 A+B

Grösse cm	Gewicht m ²	m ² /Pal.	CHF/m ²
60x60	47,3	23,04	72.00
90x90	46,3	24,30	74.00
60x90	44,4	24,30	72.00
120x60	45,2	23,04	52.00



alle Preise exkl. MwSt

alle Preise exkl. MwSt

1.4.3 Ardesia 20

rektifiziert



beige

grau

anthrazit

Format cm	kg/ m ²	m ² / Palette	CHF/ m ²
60 x 60 x 2	47	23,04	62.00
45 x 90 x 2	47	21,87	69.00



1.4.4 Pietra Beola 20

rektifiziert



grau

sand

Format cm	kg/ m ²	m ² / Palette	CHF/ m ²
45 x 90 x 2	43	21,87	59.00



1.4.5 Pietra di Vals 20

Natursteinoptik, Format 40 x 120 x 2 cm, rektifiziert

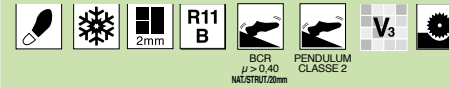

grau

anthrazit

kg/ m ²	m ² / Palette	CHF/ m ²
48	23,04	90.00

1.4.6 Pietre D'Italia

Natursteinoptik, Format 40 x 120 x 2 cm, rektifiziert



beige

grau

kg/ m ²	m ² / Palette	CHF/ m ²
47	23,04	90.00

1.4.7 Atmos 20 **neu**

Natursteinoptik, 2 cm stark, rektifiziert

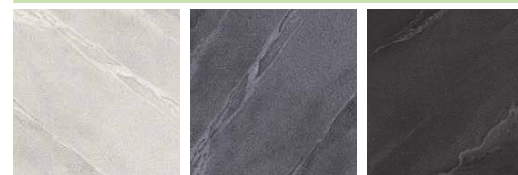

hellgrau

grau

anthrazit

Format cm	kg/ m ²	m ² / Palette	CHF/ m ²
60 x 60	46	23,04	52.00
60 x 120	46	21,6	72.00





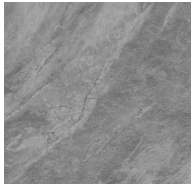
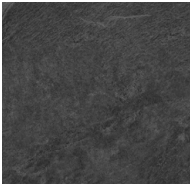

alle Preise exkl. MwSt

1.4.8 Interiorstone 20 neu Steinoptik, 2 cm stark, rektifiziert

	Format cm	kg/m ²	m ² / Palette	CHF/m ²
	60 x 60	47	23,04	52.00
	60 x 90	47	25,92	72.00
	60 x 120	47	21,60	72.00

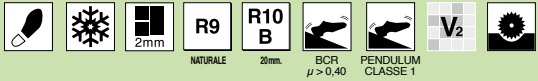

1.4.9 Silverstone 20 Steinoptik, Format 60 x 60 x 2 cm, rektifiziert

				kg/m ²	m ² / Palette	CHF/m ²
				46	23,04	62.00



alle Preise exkl. MwSt

1.4.10 Slate 20 Steinoptik, Formate: 50x100x2 cm und 80x80x2 cm, rektifiziert

	kg/m ²	m ² / Palette	CHF/m ²
	48	28,80 (50x100)	90.00
		25,00 (80x80)	

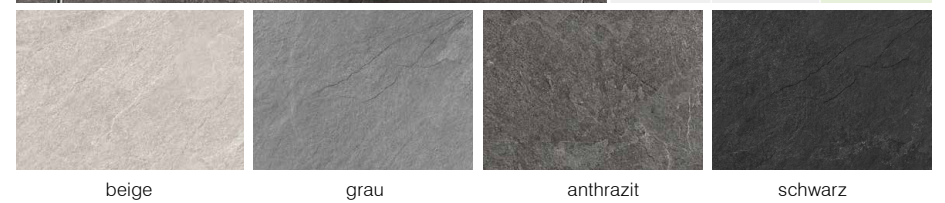

1.4.11 Pietra Regale 20 rektifiziert Formate

	kg/m ²	m ² / Palette	CHF/m ²
60 x 60 x 2 cm	43,23	23.04	59.00
60 x 120 x 2 cm	43,23	21.60	80.00
60 x 60 x 3 cm	70,45	15.84	99.00

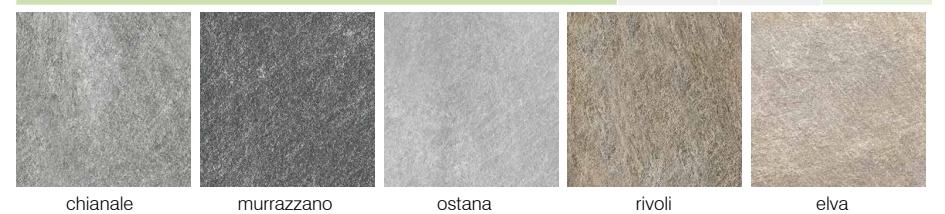

alle Preise exkl. MwSt

1.4.12 Concreta 20 rektifiziert	kg/ m ²	m ² / Palette	CHF/ m ²
60 x 60 x 2 cm	43,23	23.04	59.00
90 x 90 x 2 cm	43,23	25.92	80.00
120 x 120 x 2 cm	43,23	25.92	101.00
60 x 60 x 3 cm	70,45	15.84	99.00



terra grigio chiaro grigio tonale

1.4.13 Craft 20 neu rektifiziert	kg/ m ²	m ² / Palette	CHF/ m ²
60 x 60 x 2 cm	45,3	23,04	52.00
90 x 90 x 2 cm	46,7	24,30	74.00
60 x 120 x 2 cm	48	21,6	72.00



hellkhaki warm grey steel grey dark copper

1.4.14 urban 20 rektifiziert	kg/ m ²	m ² / Palette	CHF/ m ²
60 x 60 x 2 cm	48	23.04	62.00
80 x 80 x 2 cm	48	28,80	80.00



grau taupe schwarz

alle Preise exkl. MwSt

1.4.15 Portland 20 Format 60 x 60 x 2 cm, rektifiziert	kg/ m ²	m ² / Palette	CHF/ m ²
	47	23,04	62.00



sand grey black

1.4.16 Concept XT20 Format 60 x 60 x 2 cm	kg/ m ²	m ² / Palette	CHF/ m ²
	45	23,04	62.00

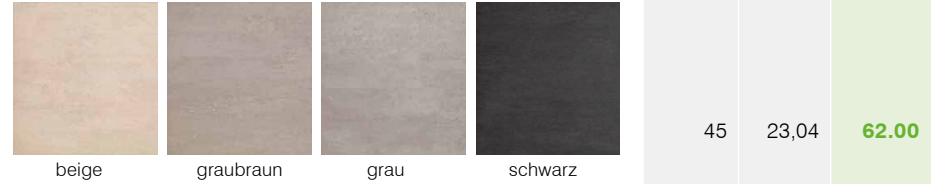

beige graubraun grau schwarz



alle Preise exkl. MwSt

1.4.17 System N20

Format 60 x 60 x 2 cm, rektifiziert, leicht strukturiert



hellgrau, mittelgrau, dunkelgrau

kg/ m ²	m ² / Palette	CHF/ m ²
45	20,16	62.00

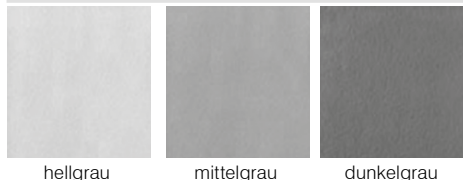

1.4.18 Treverkhome 20

Holzoptik, rektifiziert



Frassino

Rovere



Larice

Quercia

Format cm	kg/ m ²	m ² / Palette	CHF/ m ²
40 x 120 x 2	48	23,04	90.00
60 x 60 x 2	46	23,04	62.00



alle Preise exkl. MwSt

1.4.19 Wood Mood rektifiziert 45 x 90 x 2 cm

kg/ m ²	m ² / Palette	CHF/ m ²
47 kg	21,87	69.00



grau



beige



braun





ab CHF 449.00

Digitale Generation

Bis zu 120 kg Tragfähigkeit

FXAH-120-GRABO-PRO

Schnelles und ergonomisches Heben, Versetzen und Verlegen von Betonplatten, Natursteinen, Keramik- und Glasplatten sowie sonstigen saugdichten Baustoffen.

inkl. Kunststoffkoffer (wasserdicht, bruchfest und staubgeschützt) + 1 Akku



Hand-Vakuumheber **FXAH-120-GRABO-PRO**



★★
STANDARD

Steintrennmaschine TBE400

Artikel Nr.	10998400
Max. Schnitttiefe	125 mm
Max Sägeblatt Ø	400 mm
Schnittlänge	600 mm
Sägeblattdrehzahl	2 800 U/min
Sägeblattaufnahme Ø	25,4 mm



Artikel Nr.	Bezeichnung
Gemäss Angabe	verschiedene Durchmesser und Qualität



1.5 Plattendzubehör Volfi

1.5.1 Fugenkreuze, Höhe: 10mm abbrechbarer Schenkel	B/H.L in mm	VP- Einheit	Art. Nr.	CHF/Stk		
FK-A schwarz, Beutel	2/10-55	15x100	714 020	0.11		
	3/10-55	16x250	714 431	0.11		
	4/10-55	14x250	714 441	0.13		
	5/10-55	10x100	714 051	0.16		
	8/10-55	10x100	714 081	0.46		
FK-A transparent, Beutel	3/10-55	13x100	714tk031	0.22		
FK-T schwarz, Beutel	2/10-55	24x100	714 220	0.11		
	3/10-55	16x100	714 231	0.11		
	3/10-55	16x250	714 631	0.11		
	4/10-55	13x100	714 241	0.13		
	5/10-55	12x100	714 251	0.16		
	8/10-55	10x100	714 281	0.46		
FK-T transparent, Beutel	3/10-55	100	714tk231	0.22		
Fugenkreuze, Höhe: 19mm						
FK-A schwarz, Beutel	3/19-55	10x100	714 032	0.12		
	4/19-55	10x250	714 442	0.14		
	5/19-55	9x100	714 052	0.17		
	6/19-55	8x100	714 062	0.31		
	8/19-55	8x100	714 082	0.39		
FK-A transparent, Beutel	3/19-55	10x100	714tk032	0.23		
FK-T schwarz, Beutel	3/19-55	16x250	714 632	0.12		
	4/19-55	10x100	714 242	0.14		
	5/19-55	10x100	714 252	0.17		
	6/19-55	10x100	714 262	0.31		
	8/19-55	10x100	714 282	0.44		
Fugenkreuze, Höhe: 30mm						
FK-F schwarz, fester Schenkel	10/30-40	100	718 390	0.77		
	12/30-40	100	718 394	0.82		
FK-T schwarz, T-Schenkel	15/30-45	100	718 397	0.88		
	10/30-40	100	718 290	0.77		
	12/30-40	100	718 294	0.82		
	15/30-45	100	718 297	0.88		
	1.5.2 Fugenkreuz mit Bodenplatte					
FK-B, fester Schenkel, schwarz:	2/12-40	100	716 021	0.36		
	3/12-50	100	716 031	0.36		
	5/12-40	100	716 051	0.60		
	8/12-50	100	716 081	1.22		
	transparent klar:	2/12-50	100	716tk020		0.52
FK-BT, T-Stück, schwarz:	3/12-50	100	716tk031	0.52		
	4/12-50	100	716tk041	0.60		
	5/12-50	100	716tk051	0.82		
	transparent klar:	2/12-50	100	716tk220		0.52
	3/12-50	100	716tk231	0.52		
4/12-50	100	716tk241	0.60			
5/12-50	100	716tk251	0.82			

1.5.3 Pflasterabstandhalter (nur ganze VE erhältlich)	Fugen- Breite/Höhe mm	VP- Einheit	Art. Nr.	CHF/Stk
OE-T , Pflasterabstandhalter Kunststoff, 3-Rohr, für Begrü- nungsfugen oder als Rasen- fugenkreuz	25/25	500	718 520	0.98
	30/30	500	718 530	0.98
OE-K , Pflasterabstandhalter, Kunststoff, 4-Rohr	25/25	500	718 560	1.04
	30/30	250	718 570	1.04



1.5.4 Plattenlager Volfi	Fugen- Breite/Höhe mm	Art. Nr.	VE	VE CHF/ Stk	einzel CHF/ Stk
WK-U Lager, Kunststoff, 95/10mm, Noppenboden	3/10	710 031	380	1.10	1.25
	4/10	710 041	360	1.10	1.25
	5/10	713 051	60	1.10	1.25
	6/10	713 061	60	1.10	1.25
WK-UT , Lager, T-Stück für Läuferverbund	3/10	713 331	380	1.10	1.25
WK-UI Lager, Weichkunst- stoff, 95/10mm	3/10	713 431	60	1.10	1.25
	10/10	713 481		1.53	1.65
WK-UR Randstück	3/10	713 131	60	0.99	1.11
WK-L mit L-Schenkel, Noppenboden	Aufbauhöhe 10	713 092	60	1.10	1.25
GK-U Lager, gummierter Kunststoff, 95/10mm, extra weich, Noppenboden,	3/10	723 031	60	2.19	2.32
GK-UA Ausgleichscheibe, gummierter Kunststoff, mehrfach stapelbar, 95mm	1 mm grau	723 510	100	0.60	
	2 mm weiss	723 520	100	0.65	
	2,5mm schwarz	723 525	100	0.76	
WK-UK Stapelklemme, zum Stecken bei Erhöhungen	85/28	713 590	100	0.57	
WG Weich-Gummiplatte, stapelbar aus Granulat 125x125 mm	3 mm	717 003	350	0.75	0.90
	10mm	717 010	200	1.02	1.20



Plattenlager Volfi	Fugen- Breite/Höhe mm	Art. Nr.	VE	VE CHF/ Stk	einzel CHF/ Stk
WG-R3 Weich-Gummirolle, aus hochwertigem Granulat, 150mmx20m	3 mm	717 014	1		79.20
WG-R4 Weich-Gummirolle, aus hochwertigem Granulat, 250mmx5m	4 mm	717 015	1		46.00
UG-R30 Universal Gummiband EPDM für Dehnungsfugen, selbstkle- bend, 30mmx10m	3 mm	717 018	1		41.00
Scheibe/Platte Ø140 mm, Höhe 2-10 mm					
Platte, gummierter Kunst- stoff, Unterbau für Teller, ZRV zur Schalldämpfung und Entkopplung, für feste Unter- gründe	VP-GKU ohne Stege	729 790	20	2.80	
	4 Stege	728 744	280	2.20	2.80
Volfi Teller Ø140 mm					
Teller, mehrfach stapelbar, Spezial-Hartkunststoff, pas- send für Fugenkreuze mit Bodenplatte, teilbar in Rand+Eckstücke	VT-B15 4 Stege				
	Fuge 3/10mm Fuge 4/10mm Aufbau 15mm	709 031 709 041	280 280	0.80 0.80	1.20 1.20
Teller, mehrfach stapelbar, Spezial-Hartkunststoff, Boden glatt, 4 Stege, Fuge 4/10mm,	VT-U20 Aufbau 20mm	709 241	210	2.64	3.30
	VT-U50 Aufbau 50mm	709 341	80	3.30	3.90
Ausgleichring, entkoppelnder Untersetzer für Höhenaus- gleich, rutschfest, mehrfach stapelbar	Standart:				
	VT-A 1 mm	719 510	50	0.76	0.96
	VT-A 2,5 mm	719 525	50	0.98	1.18
	Vollmaterial: VT-A 2 mm	719 520	50	1.20	
	VT-A 3 mm	719 530	50	1.64	
Kombiteller, Einlegeteller und Adapter für Lager	KT ohne Fuge Aufbau 15mm	709 000	280	1.42	2.10
Kombiteller selbstnivellierend bis zu 8% Untergrundgefälle	KT-N Aufbau ca.32mm	709 003	120	2.19	2.80



Volker Fischer

VOLFI-Systeme für die moderne Plattenverlegung

Premium Dreh-Stelzlager

TESTURTEIL
Haus & Garten Test
sehr gut
(1,3)
 VOLFI TL-V
 Dreh-Stelzlager System
 Im Test: Stelzlager
 Ausgabe 3/2021 • www.haus-garten-test.de



→ integrierte Rückdrehsicherung

→ mit 4, 3, 2 Fugenstegen, ohne Fugenstege oder mit L-Schenkel

→ hochwertige gummierte Auflagefläche

→ Aufbauhöhen von 20 bis 265mm

VOLFI Volker Fischer GmbH
 D-57399 Kirchhundem

alle Preise exkl. MwSt

1.5.5 Volfi Schraub-Stelzlager ZR-V	Art. Nr.	VE	VE CHF/ Stk	einzel CHF/Stk	
Zahnrad-Schraub-Stelzlager, 31 mm Fugensteghöhe für dünne Keramikplatten,	ZR-V2 Fuge 2mm	709 941	100	6.30	6.80
31 mm Fugensteghöhe, für Beton- + Keramikplatten	ZR-V3 Fuge 3mm	709 943	100	6.30	6.80
31 mm Fugensteghöhe, für Beton- + Keramikplatten	ZR-V4 Fuge 4mm	709 944	100	6.30	6.80
Schraub-Adapter Alu zum Eindrehen der Zahnräder	ZRV-A	719 999	1		79.90



1.5.6 Volfi Stelzlager stufenlos verstellbar						
RT-V für geringe Aufbauhöhen verstellbar, 10-15 mm	RT-V 4/10 Kreuzfugen	717 443	100	2.00	2.80	
	RT-VT 4/10 T-Fugen	717 444	100	2.00	2.80	
Erhöhungs-Adapter für RT-V mit Noppenboden	RT-E5 5mm	717 514	20	1.25	1.80	
	RT-E10 10mm	717 515	20	1.50	2.00	
SK-V , für mittleren Höhenausgleich, verstellbar	NM1 401 25-40 mm	617 531	20	4.00	4.50	
	NM2 402 40-70 mm	617 532	20	4.70	5.20	
	NM3 403 60-100 mm	617 533	20	5.40	5.90	
	NM4 404 90-160 mm	617 534	20	6.50	7.00	
	NM5 405 150-270 mm	617 535	20	7.80	8.30	
				/1080 /840 /720 /480 /300		
SK-VN , selbstnivellierend bis max. 5%, verstellbar ohne Verlängerung, 4 abbrechende Fugenstege PREIS-HIT!	SE0 400 28-38 mm	617 560	25	6.20	6.70	
	SE1 401 38-50 mm	617 561	25	6.70	7.20	
	SE2 402 50-75 mm	617 562	25	7.20	7.80	
	SE3 403 75-120 mm	617 563	25	7.90	8.60	
	SE4 404 120-170 mm	617 564	25	8.50	9.20	
	406 140-230 mm	717 566	25	12.50	13.50	
	407 185-275 mm	717 567	25	13.20	14.00	
				/800 /600 /450 /400 /300		



1.5.7 Volfi Dreh-Stelzlager modular - Premium-Qualität Spezialkunststoff, integrierte Rückdrehsicherung, stufenlos im Ganzen verstellbar, mit gummierter Auflageplatte.

Stabile, nicht abbrechende Fugenstege (10 mm hoch) für 7 Fugenbreiten. 4 Varianten von Auflagen: ohne Stege, mit 2, 3 oder 4 Stegen

Für Fugenbreiten: 2, 3, 4, 5, 6, 8, 10mm oder ohne Stege		VE	VE CHF/Stk	einzel CHF/Stk
TL-V 20	20 - 26 mm	80	4.95	5.45
TL-V 30	30 - 45 mm	60	5.15	5.65
TL-V 45	45 - 75 mm	40	6.10	6.60
TL-V 75	75 - 135 mm	20	8.20	8.70
TL-V 135	135 - 175 mm	20	11.65	12.15
TL-V 145	145 - 265 mm	20	14.70	15.20

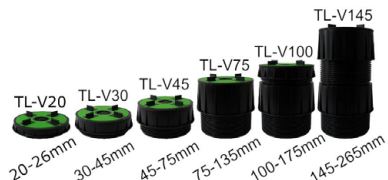
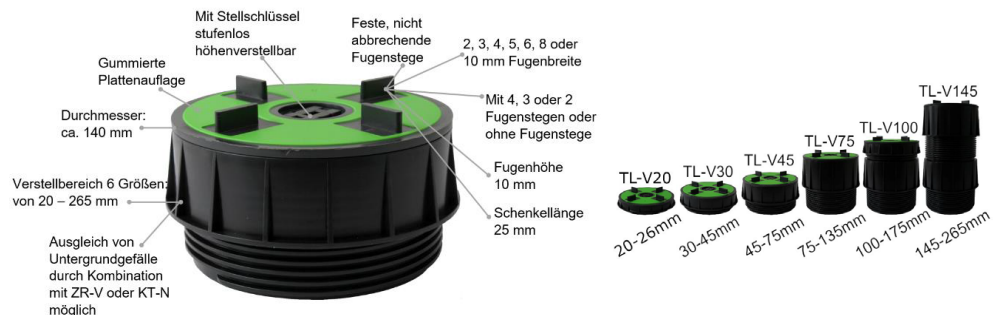
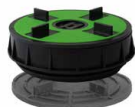

1.5.8 Zubehör

Zubehör	Artr. Nr.	VE	VE CHF/Stk	einzel CHF/Stk
Stellschlüssel Stahl für SK-VS, SKV oder SK-VN	717 556	1		74.00
Wandabstandhalter für Fuge 2 - 4 mm, Edelstahl Fuge 8 - 10 mm, Edelstahl	WAE-K14	717 609	500	4.40
	WAE-K18	717 614	10	7.25
Stufen-Clip-Set, Edelstahl, 2-teilig oben & unten, für leichte Platten bis 20 mm	136/187mm	717 547	1	20.50



1.5.9 ABK-Plattenaufleger transparent

ABK-Plattenaufleger transparent	VE	Stk/P	CHF/P	
Kreuz X10, 3mm	Ø50/H10mm	10x100	100	27.50
T-förmig, T10, 3mm	Ø50/H10mm	10x100	100	23.50
Kreuz X17, 3mm	Ø50/H17mm	10x100	100	29.50
T-förmig, T17, 3mm	Ø50/H17mm	10x100	100	29.50



1.6 Fallschutzplatten

1.6.1 Fallschutzplatte Typ Regupol FX

durchgehend Gummigranulat, abriebfest, 100 x 50 cm Geprüft nach prEN 1177-Norm, bfu-empfohlen

Stärke in mm	BFU-Empfehlung kritische Fallhöhe in cm	m²/Pal.	rotbraun-schwarz CHF/m²	grün-schwarz CHF/m²
50	150	19	130.00	141.00
75	220	12	158.00	169.00

Inkl. werkseitige Bohrung und Dübel * nur auf Bestellung

BFU geprüft!



1.6.2 Fallschutzplatte Terralastic

Gummigranulat, 50 x 50 cm, mit Steckverbinder

Stärke in mm	kritische Fallhöhe in cm	m²/Pal.	rotbraun-CHF/m²	grün-CHF/m²
45	150	30	78.00	82.00
80	250	25	92.00	96.00



1.6.3 Fallschutz Rasengitter Terrasoft

Recycling-Kautschuk, grün, , Fallhöhe 2,1m

100 x 100 x 6,5 cm	kg/Stk	VE	CHF/m²
	24	25	86.00

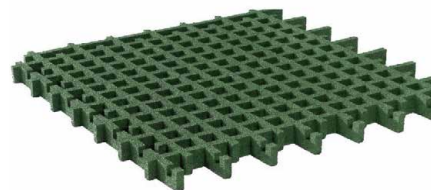

Leistungsstarke Komplettsysteme für den Schutz von hochwertigen Belägen.

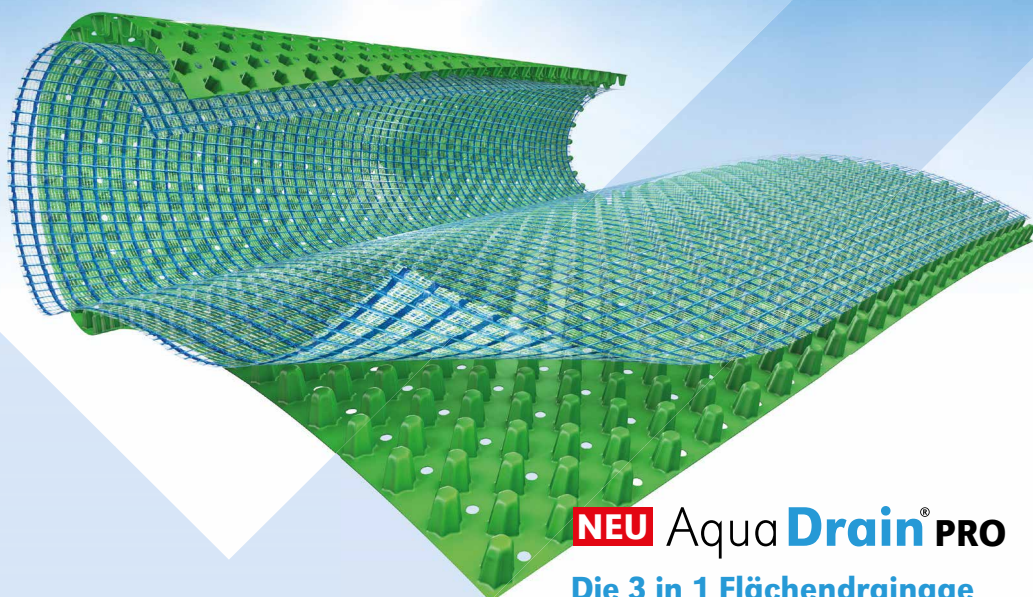

NEU Aqua Drain[®] PRO

Die 3 in 1 Flächendrainage für alle Verlegearten.

Mit 30 Jahren Erfahrung als Spezialist für die sichere Entwässerung von Aussenbelägen hat GUTJAHR jetzt eine Flächendrainage entwickelt, die sowohl für die Verlegung auf Drainmörtel, auf Kies/Splitt, sowie als punktweise Fixierung nach dem TerraMaxx[®] PF Verfahren geeignet ist. AquaDrain[®] PRO ist eine hochleistungsfähige Kombi-Drainage, die alle Stärken der bisherigen GUTJAHR Drainagesysteme in einem Produkt vereint.

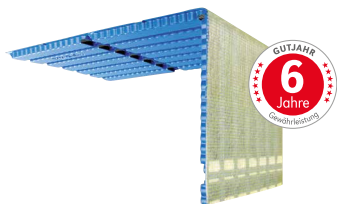

Aqua Drain[®] SD
Stufendrainage

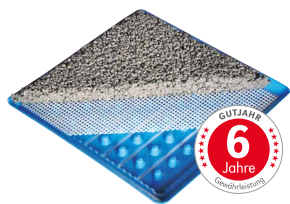

TerraMaxx[®] DS
Drain-Stelzlager

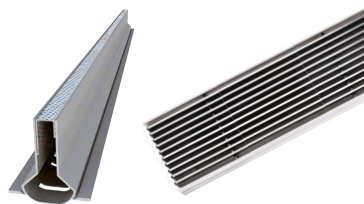

Aqua Drain[®] SR/FLEX-SL
Drainroste und -rinnen

GUTJAHR Philipp-Reis-Str. 5-7 Tel.: +49 (0) 6257 9306-0 info@gutjahr.com
Systemtechnik GmbH D-64404 Bickenbach Fax: +49 (0) 6257 9306-31 www.gutjahr.com

Sicher besser.
GUTJAHR

alle Preise exkl. MwSt

1.7 Drainage-Produkte

1.7.1	Gutjahr Drainageprodukte für Aussenbeläge	Einheit	CHF
	AquaDrain Pro , Flächendrainage für alle Verlegearten Rolle 10 mm Rolle 16 mm Rolle 25 mm (ungelocht)	Rolle/10m ² Rolle/10m ² Rolle/10m ²	29.90/m² 33.30/m² 36.15/m²
	AquaDrain T+ 8 Rollen 1 x 10 m für lose Verlegung im Splittbett 8 mm	10m ²	29.80/m²
	AquaDrain T+ 16 Rollen 1 x 10 m für lose Verlegung im Splittbett 16 mm	10m ²	35.40/m²
	WaterDrain KP Platte 1,02 x 1,96 m, Plattenverlegung im Dünnbett, 16m ² /Karton 9 mm	112m ²	Palettweise 38.00/m² Kartonweise 41.03/m²
	AquaDrain HB-16 Rollen 1 x 15 m für befahrenen Bereich 16 mm	15m ²	31.58/m²
	AquaDrain EK-8 Rolle 1 x 10 m für feste Verlegung im Splittmörtel 8 mm	10m ²	29.80/m²
	AquaDrain EK-16 Rolle 1 x 10 m für feste Verlegung im Splittmörtel 16 mm	10m ²	35.40/m²
	AquaDrain SD Stufendrainage, 310/180 mm x 1 m, für Treppen	5 Stk.	28.86/Stk
	AquaDrain SD Stufengitter, 260/140 mm x 1 m, für Treppen	5 Stk.	37.28/Stk
	AquaDrain SD Flächengitter 1 x 1 m für Treppenpodest, solange Vorrat	1 Stk.	46.27/Stk
	AquaDrain UB Universalband 60mm (2x30mm)	10m 25m	4.69/m 3.75/m
	AquaDrain SD Wasserleitstreifen, 10/10 x 600 mm, seitlich bei Treppen	50 Stk.	74.04/Karton
	AquaDrain RD Randdämmstreifen 80/40/8 mm x 20 m, Dämmstreifen	20m	4.16/m
	Aqua Drain SR-L Schlitzrinne Linienentwässerung 15/65 x 1000mm 15/65 x 3000mm	20/P 7/P	124.48/Stk 341.46/Stk
	Aqua Drain SR-W Schlitzrinne Wandeinbau 15/65 x 1000mm 15/65 x 3000mm	20/P 7/P	124.48/Stk 341.46/Stk

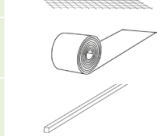
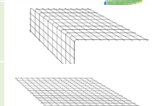
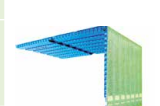
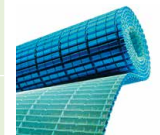
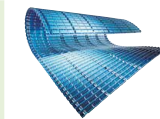
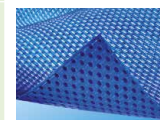
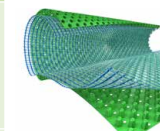

www.spaeth-shop.ch

BAUMATERIAL SPÄTH
Bau- und Gartenbedarf

DELTA®

DELTA®-TERRAXX und DELTA®-FLORAXX TOP

Starke Lösungen für begrünte Dächer.

Ideal für intensive Dachbegrünungen:

DELTA®-FLORAXX TOP. Das Schutz und Drainagesystem mit einer Wasserspeicherkapazität von 7l/m² und einer Druckfestigkeit von 200 kN/m².

Ideal zum Schutz der Dachhaut bei Dachbegrünungen:

DELTA®-TERRAXX. Die 2-Schichten-Bahn ist als wasserführendes Drainagesystem oberhalb der Abdichtung eine universelle Schutzlösung. Mit einer Druckfestigkeit von 400 kN/m² und einer Drainageleistung von 3,0l/s bietet DELTA®-TERRAXX den besten Schutz vor Stauwasser bei begrünten Dachflächen und Tiefgaragendecken.



Dörken AG
Talstrasse 47
CH-4144 Arlesheim

☎ 061 706 93 30
✉ doerken@doerken.ch
🌐 www.doerken.ch

alle Preise exkl. MwSt

1.7.2 Noppen-/Drainagebahnen aus PE	Breite m	Länge m	Stärke ca. mm	Roll./Pal.	offen CHF /m ²	ganze Rollen CHF/m ²	ganze-Palette CHF/m ²
Delta MS Original Sauberkeitsschicht, Grundmauerschutz, Sickerschicht	0,5	20	8,0		6.50	3.80	3.20
	1,0						
	1,5						
	2,0						
	2,4	20	8,0		-	3.80	3.20
	3,0						
Delta MS Drain	2,0	30	4,0			4.90	
Delta Geo Drain Quattro Vierlagiges Schutz- und Drainsystem für druckempfindliche Untergründe	2,0	12,5	9,0			14.90	
Delta Terraxx mit Trittschalldämpfung (ca. 400 kN/m ²)	2,4	12,5	9,0	17		9.80	9.00
Delta Terraxx R	2,4	12,5	9,0	17		8.30	8.00
Delta Terraxx light (ca. 200 kN/m ²)	2,4	12,5	9,0	17		7.85	7.30
Delta Terraxx Ultra für Verkehrsflächen	2,4	12,5	9,0	17		17.50	
Abschlussprofil neu zu Noppenbahn		2		20/ Bund		4.90/ m ¹	
Delta Floraxx Wasserspeichernd, fürs Umkehrdach	2	20	20,0			10.30	
Delta Floraxx Top Die wasserspeichernde für Gründächer	2	10	20,0			11.40	
Delta Floraxx für extensive/intensive Dachbegrünung sowie begeh-/befahrbar Verkehrsflächen	40H	1,04 x 2,04m x 40mm				19.00	
	60H	0,94 x 1,94m x 60mm				27.00	

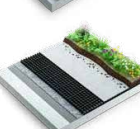
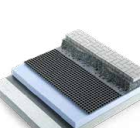
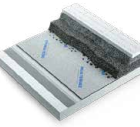

1.7.3 Sytecdrain Drainagematte neu	Stärke mm	Rollen-grösse	CHF/m ²
Flexible Flächendrainage TDF 400 (ca. 650 g/m ²)	20 mm	2.45 x 15 m	11.30/m ²



www.spaeth-shop.ch

BAUMATERIAL SPÄTH
Bau- und Gartenbedarf

1.8 Verbundsteine, Pflastersteine

1.8.1 UNI-Norm-Verbundsteine ST

Stärke in cm	m ² /Palette	kg/m ²	grau CHF/m ²
6	10,769	130	24.00
8	8,974	180	27.00

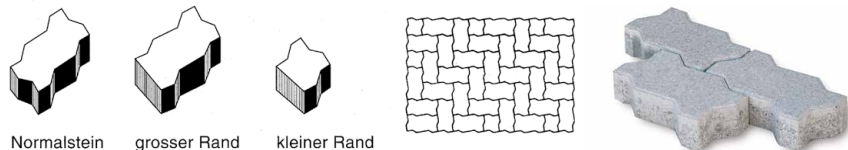

1.8.2 Doppel-T-Verbundsteine ST

Stärke in cm	m ² /Palette	kg/m ²	grau CHF/m ²
6	10,28	130	24.00
8	8,06	180	27.00
10	4,80	220	31.50

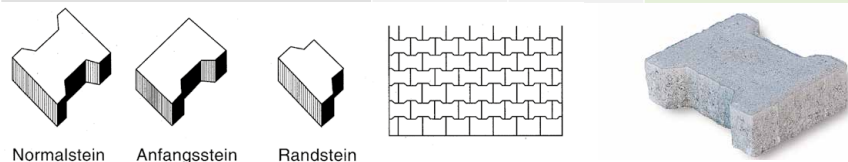

1.8.3 Rechteckstein 20 x 10 cm H&B

Stärke in cm	Farbig auf Anfrage	m ² /Palette	kg/m ²	grau CHF/m ²	braun, rot, schwarz CHF/m ²
6		9,60	130	24.00	28.00
8		8.80	180	27.00	31.00

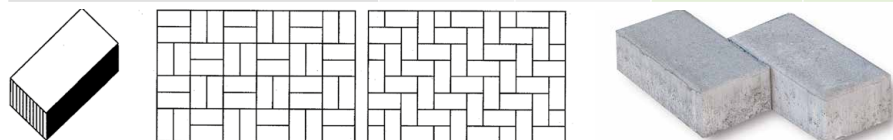

1.8.4 Carée-Pflastersteine, 20 x 20 cm

Stärke in cm	m ² /Palette	kg/m ²	grau CHF/m ²
6	9,6	130	24.00
8	9,6	180	27.00

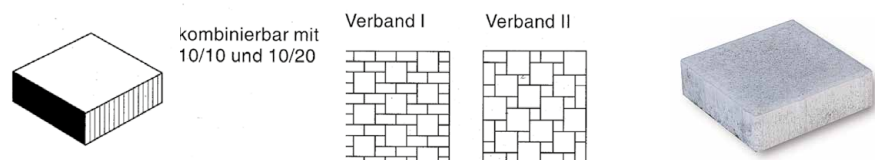

1.8.5 Quadratpflastersteine

10 x 10 cm
mit oder ohne Fase lieferbar, Bedarf 100 Stk/m²

Stärke in cm	m ² /Palette	kg/m ²	grau CHF/m ²	braun, rot, schwarz CHF/m ²
6	8,64	130	24.00	28.00
8	8,80	180	27.00	31.00



1.8.6 Einstein Verbundsteine mit Verschiebesicherung

und Minifase, 5mm Fuge

Format in cm	Stk/m ²	m ² /Pal	kg/m ²	grau CHF/m ²
10 x 20 x 6	50	9,6	125	25.00
20 x 20 x 6	25	9,6	125	25.00
30 x 20 x 6	16,667	9,6	125	25.00
10 x 20 x 8	50	7,68	170	28.00
20 x 20 x 8	25	7,68	170	28.00
30 x 20 x 8	16,667	7,68	170	28.00
25 x 25 x 6	16	9,38	125	25.00
25 x 12,5 x 6	32	9,38	125	25.00
12,5 x 12,5 x 6	64	8,44	125	25.00
25 x 25 x 8	16	7,50	170	28.00
25 x 12,5 x 8	32	7,50	170	28.00
12,5 x 12,5 x 8	64	6,75	170	28.00

Farbzuschlag für anthrazit (netto) + 4.00

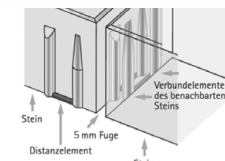
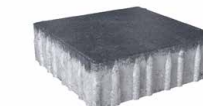

1855 l/(s x ha)

1.8.7 Rainplus LP - Diamond Edition black-star

mit Verschiebesicherung, sickerfähig, Versickerung im Neuzustand ab 3718 l/(s*ha), 4mm Fuge

Format in cm	Stk/m ²	m ² /Pal	kg/m ²	CHF/m ²
glatt				
20x10x8 cm	49,259	7,792	180	31.50
30x20x8 cm	16,529	7,774	180	31.50
kugelgestrahlt				
30x20x8 cm	16,529	7,774	180	44.00



20 x 10 x 8 cm:
3718 l/(s x ha)

30 x 20 x 8 cm:
2280 l/(s x ha)

alle Preise exkl. MwSt

1.8.8 Agora Pflaster F

gefaste Formatmix-Pflastersteine mit 3 verschiedenen Formaten.
Formate: 16x30, 16x40 und 16x50 cm, Stärke: 6 cm, nicht befahrbar!
Steine nur gemischt und in ganzen Paletten erhältlich!



Farben	m ² /palette	kg/m ²	CHF/m ²
Grau,	9,6	138	29.00
Cendre (Asche), Corail	9,6	138	43.50



grau

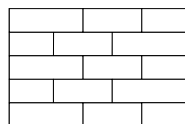

cendre

corail

1.8.9 VISTA-Pflaster D

Modernes, gefastes längliches Pflaster mit 4mm Fugen und **Verschiebesicherung** (ohne Imprägnierung)
Farben: ziegelbrand, sandgelb



Formate	m ² /palette	kg/m ²	CHF/m ²
45 x 15 x 8 cm	5,448	180	36.00

2423 l/(s x ha)



ziegelbrand



sandgelb

alle Preise exkl. MwSt

VISTA-Pflaster gestraht D

in grossen, kombinierbaren Formaten,
mit **Verschiebesicherung**,
4 mm Fugen und b.c.s. Oberflächenschutz



30 x 15 x 8 cm	7,272	62.50
30 x 30 x 8 cm	8,698	62.50
45 x 15 x 8 cm	5,448	62.50
60 x 30 x 8 cm	8,683	62.50

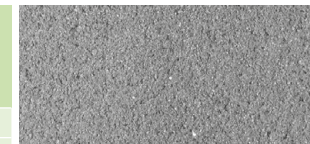
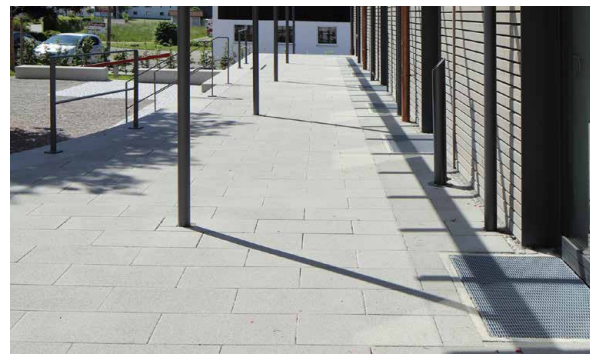

sophistograu



achatgrau



oysterbeige

30x30x8: 1867 l/(s x ha)
45x15x8: 2423 l/(s x ha)
60x30x8: 1423 l/(s x ha)

1.8.10 VISTA-Selection D

mit Oberflächenschutz



Schlank proportionierte Formatmix-Pflastersteine mit 5 verschiedenen Formaten. Verschiebesicherung, versickerungsfähig, Steine nur gemischt erhältlich! 15 - 60x15/20cm, 8 cm stark

Farben	m ² /palette	kg/m ²	CHF/m ²
sophistograu, (kugelgestraht)	7,746	180	64.00
muschelkalk, titan (klassisch)	7,746	180	57.00



2295 l/(s x ha)

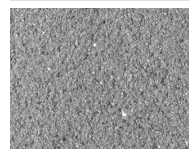

sophistograu



muschelkalk



titan

C	A	D
C	C	B
E	E	
D	A	C
B	D	B



alle Preise exkl. MwSt

1.8.11

VISTA-Edition neu



mit Oberflächenschutz, zeitloser Formatmix-Zierverband aus drei Formaten. Versickerungsfähig, Steine nur gemischt erhältlich! 15x15/30x15/30x30cm, 8 cm stark

Farben	m ² /palette	kg/m ²	CHF/m ²
sophistograu, achatgrau (kugelgestrahlt)	7.265	180	51.00
muschelkalk, titan (klassisch)	7.265	180	46.00



titan



sophistograu achatgrau muschelkalk titan

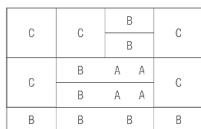

muschelkalk

1.8.12

Avenue Pflaster L



Formatmix-Pflastersteine mit 8 verschiedenen Formaten. Die Steine sind nur gemischt erhältlich! 8 cm stark

Farben	m ² /palette	kg/m ²	CHF/m ²
Brooklyn (anthrazit glitzernd)	8.060	180	60.00
Toledo (grau glitzernd)	8.060	180	60.00
Corail (muschelkalk)	8.060	180	60.00
Cendre (asche)	8.060	180	60.00



toledo



brooklyn corail cendre

alle Preise exkl. MwSt

1.8.13

Sortett-Selection L



mit Oberflächenschutz moderne, scharfkantige Formatmix-Pflastersteine mit 4 verschiedenen Formaten. Verschiebesicherung, versickerungsfähig, Steine nur gemischt erhältlich! 14,2 - 24,9x17,8cm, 8 cm stark

Farben	m ² /palette	kg/m ²	CHF/m ²
muschelkalkmix, titan	8.365	180	59.00
grau neu	8.365	180	39.00



3222 l/(s x ha)



.....muschelkalkmix titan grau



muschelkalkmix

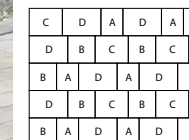

1.8.14

Via Roma Gestaltungs Pflaster



mit Oberflächenschutz moderne, scharfkantige Formatmix-Pflastersteine, Mischung aus 10 Formaten, 3 Bahnenbreiten, versickerungsfähig, Steine nur gemischt erhältlich! Formate: 24-44/16-28/8 cm

Farben	m ² /palette	kg/m ²	CHF/m ²
muschelkalk, titan	7.68	180	50.50



1991 l/(s x ha)



muschelkalk titan

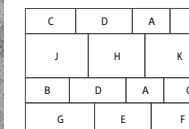

muschelkalk

LITHON



Trento Selection dunkelgrau

LITHON



Pasand oysterbeige

alle Preise exkl. MwSt

1.8.15 La Linia Pflaster
mit Fase, kugelgestrahlte Oberfläche

Birkenmeier
stein+design

Format	Dicke/cm	Stk/m ²	m ² /Pal	kg/m ²	CHF/m ²
granitweiss, granithell, basaltanthrazit					
10 x 10 cm	6	100	9,60	133	62.20
20 x 10 cm	6	50	9,60	133	62.20
20 x 20 cm	6	25	9,60	133	62.20
30 x 20 cm*	6	16,7	9,60	133	62.20
granitweiss, granithell					
20 x 20 cm	8	25	7,20	180	70.90
30 x 20 cm	8	16,7	7,20	180	70.90
basaltanthrazit					
20 x 10 cm	8	50	7,20	180	70.90
20 x 20 cm	8	25	7,20	180	70.90

*in basaltanthrazit nicht erhältlich



granitweiss

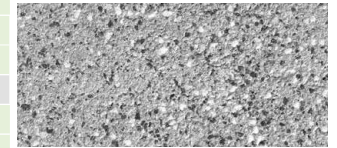

granithell

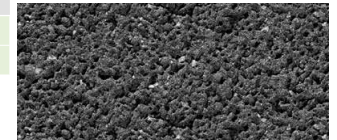

basaltanthrazit

1.8.16 La Linia SL Pflaster

Birkenmeier
stein+design

ohne Fase, mit Verschiebesicherung SL, kugelgestrahlt

Format	Dicke/cm	Stk/m ²	m ² /Pal	kg/m ²	CHF/m ²
mittelgrau, graphit-anthrazit					
20 x 20 cm	8	25	7,20	170	77.30
30 x 20 cm	8	16,7	7,20	170	77.30
40 x 20 cm	8	12,5	7,20	170	77.30
80 x 40 cm	8	3,13	5,12	180	77.30



mittelgrau



graphit-anthrazit



mittelgrau

alle Preise exkl. MwSt

1.8.17 Antinea Pflaster Lino

changierende Farben,
mit scharfkantiger Linienführung

Birkenmeier
stein-design

Format in cm	Dicke/cm	Stk/m ²	m ² /Pal	kg/m ²	CHF/m ²
13,3 x 6,6 cm	8	114	6,95	180	64.90
13,3 x 13,3 cm	8	57	7,64	180	64.90
20,0 x 13,3 cm	8	38	7,66	180	64.90
26,6 x 26,6 cm	8	14	6,79	180	64.90



muschelkalk



schiefergrau



1.8.18 Piazza Pflastersteine gefast

auch zum Erstellen von
Kreisen. Höhe: 6 cm

	m ² / Palette	Stk / m ²	kg / m ²	grau CHF/m ²	anthrazit erdbraun, CHF/m ²
Normalstein 11,5 x 11,5 cm	8	75	130	40.50	46.70
1 1/2 Normalstein 17,2 x 11,5 cm	8,4	50	130	40.50	46.70
1/2 Normalstein 11,5 x 5,7 cm	3,6	150	130	59.50	68.00
kleiner Kreisstein 11,2 x 8,6 cm		90	130	59.50	68.00
grosser Kreisstein 11,2 x 11,5 cm		80	130	59.50	68.00

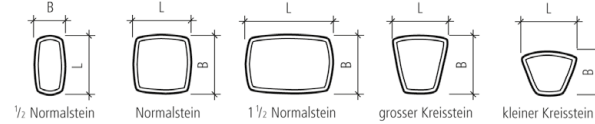

1.8.19 Spartana-Antik-Pflastersteine (getrommelt)

Farben



	m ² /Lage	m ² /Palette	6 cm CHF/m ² palettiert	8 cm CHF/m ² palettiert
Grau	0,857	10,29	46.50	49.50
Graumix, Weinlaub, Buntmix, Braunmix, Terrakotta, SchwarzWeiss, GelbWeiss, Muschelkalk, Anthrazit	0,857	10,29	48.50	52.50
Bühler Kreis, kompletter Satz Ø 244 cm, inkl. Papierschablone			400.00	440.00



Technische Daten:
Größen:

- Quadratstein: 12,6 x 12,6 cm
- Halbstein: 12,6 x 6,3 cm
- Rechteckstein: 18,9 x 12,6 cm
- Rechteckstein: 25,2 x 12,6 cm nur in 6cm Stärke!



* Anbruch: Nur Lagenweise pro Format! Rüst-Zuschlag für Kleinmengen CHF 8.00/Format
 bei Farbmix-Varianten sind Farbdifferenzen unvermeidbar!

probst
handling equipment

Vermessen - Kennzeichnen - Führen
Innovative Lösungen zum
Handling Ihrer Baustoffe.

CHF 74.75

Mess- und Anreisslehre **MAL**

CHF 184.00

Flexmarker-Kit **FMK**

CHF 21.85

Richtschnurhalter **RSH**

RAINA DRAIN ÖKOSTEINE

Mit dem Ökostein für mehr Nachhaltigkeit

Der RAINA DRAIN trumpft nicht nur mit seinen drei verschiedenen Formaten und seinen schlichten Farben. Er leistet mit seiner beeindruckenden Versickerungsleistung einen wesentlichen Beitrag gegen die Bodenverdichtung. Er überzeugt also in Sachen Ästhetik und Funktionalität gleichermaßen. Erfahren Sie mehr über unseren Öko-Star.



Nutzen Sie den Weblink
für mehr Details.
betonlink.ch/raina

1.8.20 Kleinpflaster neu D
getrommelte Formatmix-Bogenpflastersteine Steine nur
gemischt erhältlich! 6 Formate: 7/9 - 12/9 cm

Farben	m ² /palette	kg/m ²	CHF/m ²
muschelkalkmix titan	7,312	180	*42.00

* nur im Big-Bag (zzgl. CHF 15.- je Big-Bag)



muschelkalk



titan



1.8.21 Pflaster Rustico neu D
Polygonal-Pflaster, Oberfläche strukturiert, ohne Fase-
7 cm stark

Farben	m ² /palette	kg/m ²	CHF/m ²
muschelkalk braunmix, black & white	6,24	120	48.00



muschelkalk

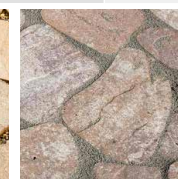

braunmix



black&white

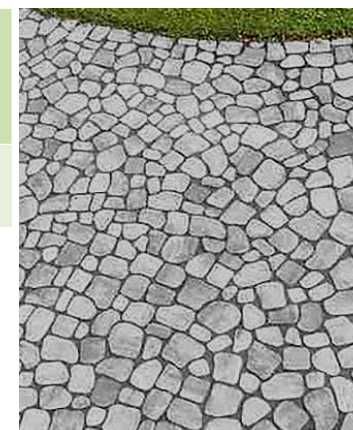

1.8.22 Wildenstein – Pflaster D
Antik-Pflaster «Wildenstein», getrommelte Formatmix-Pflaster-
steine Steine nur gemischt erhältlich! 6 cm stark

Farben	m ² /palette	kg/m ²	CHF/m ²
muschelkalk, titan b.c.s Oberflächenschutz	10,455	135	38.50



muschelkalk



titan



3222 l/(s x ha)

alle Preise exkl. MwSt

1.8.23 Wartenberg – Pflaster D

Natürlich anmutende Steinformen, bestehend aus 3 Formaten mit unregelmässigem Kantenverlauf mit strukturierter Oberfläche, 8 cm stark. Versickerungsfähig, Steine nur gemischt erhältlich. Formate: 14-28/15-22,5/8 cm
 Farben

Farben	m ² /palette	kg/m ²	CHF/m ²
muschelkalk, titan mit b.c.s Oberflächenschutz			
scharfkantig	7.68	180	54.00
leicht getrommelt neu	7.68	180	66.50



muschelkalk

titan

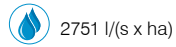

2751 l/(s x ha)



1.8.24 Trento Selection Pflaster neu

Eder Natursteincharakter, bestehend aus 3 Formaten mit strukturierten, unregelmässigen Kanten und fein gestrahlter Oberfläche, 8 cm stark. Versickerungsfähig, Steine nur gemischt erhältlich. b.c.s Oberflächenschutz, Formate: 14-28/15-22,5/8 cm
 Farben

Farben	m ² /palette	kg/m ²	CHF/m ²
hellgrau, mittelgrau, dunkelgrau	7.824	180	59.00

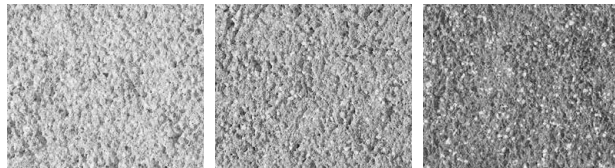

hellgrau

mittelgrau

dunkelgrau



2751 l/(s x ha)



alle Preise exkl. MwSt

1.8.25 Trento Pflaster



topografierte, fein gestrahlte Naturstein-Oberfläche Strukturierte, unregelmäßige Kantenführung, 8 cm stark. Versickerungsfähig, beliebig kombinierbar. b.c.s Oberflächenschutz, 8 cm stark
 Farben

Farben	Format cm	m ² /pal.	kg/m ²	CHF/m ²
hellgrau, mittelgrau, dunkelgrau	15x14x8	8.402	180	59.00
	22,5x14x8	7.825	180	59.00
	28x22,5x8	8.295	180	59.00

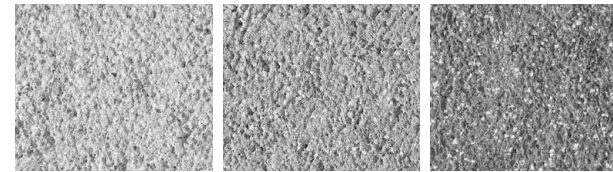

hellgrau

mittelgrau

dunkelgrau

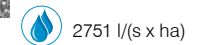

2751 l/(s x ha)

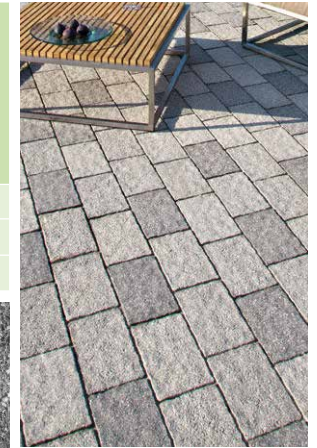

1.8.26 Châteaux Pflaster kugelgestrahlt, abgerundete Kanten,



Oeko-Belag F

Farben	Format/ cm	m ² /palette	kg/m ²	CHF/m ²
amboise	18,7 x 12,5 x 6	9,35	138	48.00
chambord	12,5 x 12,5 x 6	10,00	138	48.00
vitre				
chinon				



amboise

chambord

vitre

chinon



alle Preise exkl. MwSt

1.8.27 Antinea Pflaster Antik gekollert, changierende Farben, unregelmässige und teilweise gebrochene Kanten **Birkenmeier stein+design**

Format in cm	Dicke/cm	Stk/m ²	m ² /Pal	kg/m ²	CHF/m ²
13,3 x 6,6 cm	8	114	6,95	180	69.30
13,3 x 13,3 cm	8	57	7,64	180	69.30
20,0 x 13,3 cm	8	38	7,66	180	69.30
26,6 x 26,6 cm	8	14	6,79	180	69.30



1.8.28 Antinea Pflaster Antik Öko, versickerungsfähig gekollert, changierende Farben, unregelmässige und teilweise gebrochene Kanten **Birkenmeier stein+design**

Format in cm	Dicke/cm	Stk/m ²	m ² /Pal	kg/m ²	CHF/m ²
13,3 x 6,6	6	114	8,68	130	58.90
13,3 x 13,3	6	57	9,55	130	58.90
20 x 13,3	6	38	9,58	130	58.90
gemischt	6	wV	8,49	130	74.90
gemischt	8	wV	6,79	180	88.60



7574 l/(s x ha)

1.8.29 Pflaster Klinker, Holländer Klinker **neu** besandet, gerumpelt ohne Fase, WF 60, EN 1344, Format: 204x50x60mm

Farbe	Dicke/cm	Stk/m ²	Stk/Pal	kg/m ²	CHF/m ²
Gromo Antica (grau nuanciert)	6	96	1000	130	129.00
Lucca Antica (schwarz-silber-sand nuanciert)					124.00
Iseo Antica (braun-schwarz nuanciert)					124.00
Lugano Antica (blau-schwarz nuanciert)					124.00
Carbona Antica (schwarz nuanciert)					132.00
Bergamo Antica (multicolor)					114.00
Novara Antica (rot-braun nuanciert)					114.00



1.8.30 Sorrento Pflaster Öko Kombi, versickerungsfähig, mit Minifase längs changierende Farben, Verschiebesicherung, Formate: 30/20, 40/20, 50/20cm **Birkenmeier stein+design**

Format in cm	Dicke/cm	Stk/m ²	m ² /Pal	kg/m ²	CHF/m ²
gemischt	8	Verband	7,68	170	71.80



4225 l/(s x ha)



1.8.31 Lido Pflaster Öko Kombi, versickerungsfähig mit Minifase, changierende/uni Farben, Verschiebesicherung, nur Paletweise lieferbar

Formate, immer gemischt: (6) 42/16, 35/16, 28/16cm (8) 50/16, 40/16, 30/16 cm

Farben

Farben	Dicke/cm	Stk/m ²	m ² /Pal	kg/m ²	CHF/m ²
schiefergrau, juragrau	6	Verband	8,40	130	62.90
granitgrau-weiss, grau-anthrazit gemischt	6		8,40	130	93.20
silbergrau, anthrazitgrau	8		7,68	170	58.90
schiefergrau, beige-grau	8		7,68	170	64.90
hellgrau, mittelgrau, dunkelgrau kugelgestrahlt	8		7,68	170	82.00

Birkenmeier stein+design

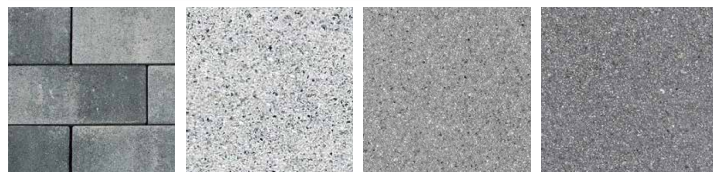

schiefergrau hellgrau mittelgrau dunkelgrau



silbergrau anthrazitgrau schiefergrau beige-grau

5767 l/(s x ha)

1.8.32 Einstein Carré Sicker-Verbundsteine mit Verschiebesicherung und Minifase, versickerungsfähig, 5mm Fuge

Format in cm	Stk/m ²	m ² /Pal	kg/m ²	grau CHF/m ²
10 x 20 x 6	50	9,6	125	25.00
20 x 20 x 6	25	9,6	125	25.00
30 x 20 x 6	16,667	9,6	125	25.00
10 x 20 x 8	50	7,68	170	28.00
20 x 20 x 8	25	7,68	170	28.00
30 x 20 x 8	16,667	7,68	170	28.00
25 x 25 x 6	16	9,38	125	25.00
25 x 12,5 x 6	32	9,38	125	25.00
12,5 x 12,5 x 6	64	8,44	125	25.00
25 x 25 x 8	16	7,50	170	28.00
25 x 12,5 x 8	32	7,50	170	28.00
12,5 x 12,5 x 8	64	6,75	170	28.00
Farbzuschlag für anthrazit				+ 4.00

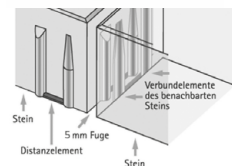

500 l/(s x ha)

1.8.33 Sicker-Pflastersteine Geoton Wasserdurchlässigkeit 600l/Sek & ha

Formate: 20 x 20 cm, 20 x 10 cm	m ² /Pal	grau CHF/m ²
6 cm	9,60	24.00
8 cm	9,60	27.50



1.8.34 Sicker-Pflastersteine (ST) Modelle: Uni-Verbund, Doppel-T, 20 x 10 / 10 x 10 / 20 x 20 cm

	m ² /Pal	grau CHF/m ²	farbig CHF/m ²
porafil fein, 6 cm	11,52	25.50	29.00
porafil fein, 8 cm	7,68	27.80	31.50

Nur auf Bestellung. Erhöhtes Risiko für Ausblühungen!



1.8.35 Drainfugenpflaster (ST) Mit 7 mm Fugenabstand

	grau CHF/m ²	anthrazit CHF/m ²
20 x 20 x 6 cm * 11,52 m ² /Pal. 130 kg/m ²	25.50	29.00
20 x 20 x 8 cm * 7,68 m ² /Pal. 175 kg/m ²	27.80	31.50

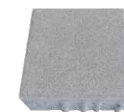

1.8.36 Rasen-/Splittfugensteine/Golf Plus mit integrierten Abstandhaltern

Grösse in cm	Fuge mm	grau CHF/m ²	anthrazit CHF/m ²
20 x 20 x 8 Splittfuge	12	26.00	30.00
30 x 20 x 8 Rasenfuge	30	26.00	30.00



1.8.37 Vista-Green Fugenpflaster modernes, lineares Rasenfugenpflaster, Fuge 25 mm

30 x 15 x 8 cm	m ² /Pal.	kg/m ²	CHF/m ²
grau glatt	7,272	140	37.30
achatgrau/sophistograu gestrahlt			60.00



1.8.38 Rasengittersteine Meba Grau

	m ² /Pal	kg/m ²	CHF/m ²
40 x 60 x 8 cm	9,60	115	22.00
40 x 60 x 10 cm	7,68	140	25.00
40 x 60 x 12 cm	6,72	160	31.00
Füllsteine 8 cm stark	728	1,2/Stk	1.20/Stk
BG-Rasengitter 40 x 60 x 11 cm	7,68	152	54.00



1.8.39 Raina Rasenliner Grau, glatt, mit Nockenverbund

	m ² /Pal	kg/m ²	CHF/m ²
60 x 40 x 10 cm	7,68	167	57.50
30 x 40 x 10 cm	7,68	167	57.50
45 x 40 x 12 cm	5,04	200	70.00
60 x 40 x 10 cm Schrittplatten	5,76	225	77.00



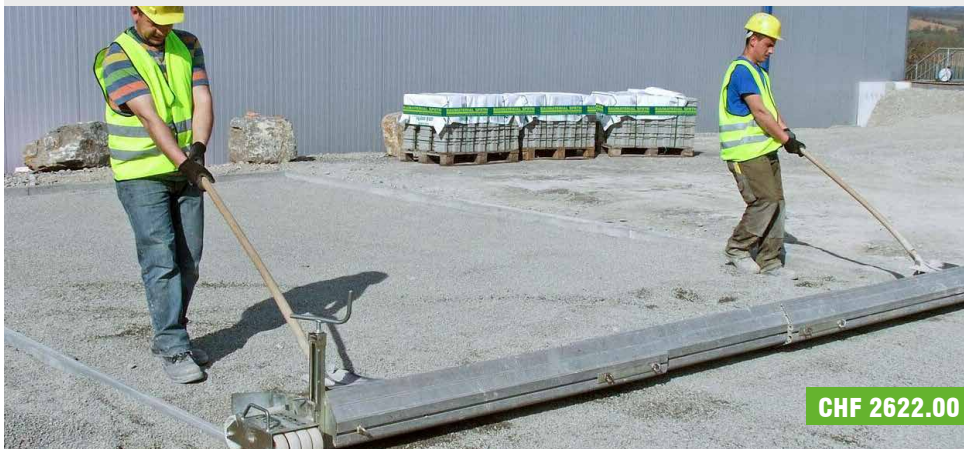

CHF 2622.00

Handabziehsystem **TAS-UNI-450**



Die digitale Generation

ab CHF 449.00

Akku-Handy **FXAH-120-Grabo-PRO**



ab CHF 2495.50

Vakuum-Handverlegegerät **SPEEDY VS**



ab CHF 924.60

Hand-Planiersystem **LEVELFIX LF**



ab CHF 420.90

Rabattengreifer **EASYGRIP EXG**



CHF 782.00

Rasengitter Verlegezange **RGV**



ab CHF 1851.50

Fertigteilstange **FTZ**

Über 100 verschiedene Probst-Produkte an Lager.
Aktuelle Preise und Lagerbestand auf www.spaeth-shop.ch



CHF 546.25

Stelensetzer **SLS-8/20-G-VA**

CHF 241.50

Bordsteinversetzzange **BVZ**



ab CHF 936.50

Schachtringgehänge **SRG-Uni**



CHF 616.40

Stone Splitter **STS-43**

Gartenbedarf

alle Preise exkl. MwSt

1.8.40 Kunststoff-Rasenwaben aus Recycling-Kunststoff	m ² /Pal	CHF/m ²
System Prestele, UV-stabil, 38 x 56 x 5 cm	31,5	33.00

Fallschutzrasengitter siehe 4.5.3



1.8.41 Kiesstabilisierer Stonefix Hochwertiges Geotextil mit Thermo- verleimung, wasserdurchlässig, UV- und frostresistent	Stk/Pal	Grösse cm	CHF/Stk
Starke Wabenstruktur ergibt ex- zellentes Schwerkraftverhalten und mehr Stabilität. Verfüllbar mit Kies, befahrbar.	42	120 x 80 x 3	27.65



1.8.42 Sytec G-Fix	CHF/m ²
Gartenkiesfixierung Rolle 1,5 x 20 m mit 500 Befestigungsnägeln	29.90



1.8.43 Sakret Kiesbinder	Gebinde kg	CHF/Gebinde
EP (2-k, lösemittelfrei)	5 10	238.45 387.30
PU-UV (1-komp.) ECO	10 20	626.35 1291.90



1.8.44 Bodenbefestigungsgitter «Grasprotecta» auf Grasflächen als provisorischer Fahrweg für Liefer- wagen und leichte Baumaschinen	Breite m	Länge m/Rolle	kg/ m ²	CHF/m ²
Material: PEHD	2	20	ca. 2	28.50
Agraffen zur Fixierung im Boden 23 cm lang 250 Stk/P.				119.00/Pack



1.8.45 Bodenschutzplatten für temporären Bodenschutz (auf Bestellung)	Belastung max.	Grösse	kg/Platte	CHF/Stk.
Euromat, schwarz, PEHD, 14 mm	80t	1.2 x 2.4 m	35	270.00
2-Plattenverbindung				15.00
4-Plattenverbindung				30.00
Stahl-Agraffen, 10 Stk/Bund		10/24 cm	7/Bund	55.00/Bund



alle Preise exkl. MwSt

1.8.46 Steinfix-Randabschlussprofil aus PVC für Pflastersteine / Platten	CHF/m ¹
Steinfix, gerade 2 m lang graubeige, H = 10 mm	20 m/Bund 5.00
Steinfix, gerade 2 m lang grau, H = 22 mm	20 m/Bund 4.50
Steinfix rund, 2 m lang grau, H = 22 mm	20 m/Bund 6.60
Steinfix Netz, 2 m lang graubeige, H = 10 mm	20 m/Bund 8.30
Steinfix Netz, 2 m lang grau, H = 22 mm	7.80
Steinfix Forte, gerade 2m lang grau, H = 50 mm	12 m/Bund 13.80
befahrbar bis 3.5 to, mit Netz 50 cm	
Passende Nägel 245 mm lang (Bedarf: ca. 3-4 Nägel pro Steinfix)	5kg = ca. 60 Stk 5.90/kg



1.8.47 Ringo Kiesring - Rückhaltung für Dachkies	CHF/ Stk
ringo Ø 356 mm, PVC, grau, H = 80 mm	10.50



1.9 Blockstufen

1.9.1 Blockstufen glatt gefast, voll Auch als Fundamente geeignet, unbewehrt	Länge cm	Stk/Pal	Gewicht kg/Stk	CHF/Stk	
Grau glatt 40 x 14 cm	60	20	81	27.60	
	80	10	108	36.80	
	100	10	135	46.00	
	120	10	162	55.20	
Grau glatt 35 x 15 cm	50	20	64	24.00	
	75	10	96	36.00	
	100	10	128	48.00	
Grau glatt 30 x 18 cm	80	15	104	52.00	
	80	15	104	52.00	
Anthrazit glatt gefast 35 x 15 cm	75 / 50 / 100	20/10	128/m ¹	*89.00/m¹	
Muschelkalkmix/Titan 35 x 15 cm	50 / 75 / 100	20/10	128/m ¹	*128.00/m¹	
Pasand, gestrahlt achat-/quarz-/sophistograu 35x15 cm	50 / 100	20/10	128/m ¹	*199.00/m¹	
BMS 01 hellgrau, BMS 11 anthrazit impr. 40x14cm	60/80/100/120	20/10	135/m ¹	*168.00/m¹	
BRAUN: impr.: Nr 153, 154, 156, 161, 165 40x14cm	60/80/100/120	20/10	135/m ¹	*176.00/m¹	
BRAUN: impr. Fiamata Nr 62, 63, 64, 66, 67, 68, 69 40x14cm	60/80/100/120	20/10	135/m ¹	*186.00/m¹	
Waschbeton Rheinkies 40x14 cm	4 - 8mm	60/80/100/120	20/10	135/m ¹	*82.00/m¹
	8 - 16mm	60/80/100/120	20/10	135/m ¹	79.00/m¹

* nur auf Bestellung, Spezialblockstufen auf Anfrage.

alle Preise exkl. MwSt

1.9.2 ATI Blockstufen grau **neu**, Trittpläche strukturiert **+**

alle Kanten 3mm gefast, Aussparung unterseitig, Stirnseite schalungsglatt

Länge cm	Breite x Höhe	Stk./Pal.	kg /Stk	CHF/Stk
50	37 x 15 cm	20	43	42.10
60		16	52	46.45
80		12	66	67.25
100		10	81	71.00
120		8	95	83.00
150		6	117	115.00
200	4	154	148.00	
50	37 x 17 cm	20	51	45.40
60		20	59	50.30
80		15	76	72.90
100		10	93	77.60
120		10	110	91.10
150		10	135	126.00
200	10	177	154.00	



1.9.3 Parco Blockstufen grau, abgerieben, gefast **+**

Stirnseite schalungsglatt

Länge cm	Breite x Höhe	Stk./Pal.	kg /Stk	CHF/Stk
50	36 x 15 cm	20	45	38.75
60		20	54	46.50
80		15	72	62.00
100		10	90	70.50
120		10	108	84.60
150		10	135	105.75
200	10	188	141.00	
50	36 x 17 cm	20	48	40.25
60		20	58	48.30
80		15	77	64.40
100		10	96	74.00
120		10	115	88.80
150		10	144	111.00
200	10	198	148.00	



1.9.4 Blockstufen mit EPS-Einlage **+**

Längen: 50, 60, 75, 80, 100, 120, 125, 150, 200 cm

	Stk/Pal	kg/m1	CHF/m1
grau, nur Trittpläche leicht gestrahlt 36 x 15 cm	6	100	81.00
grau, Trittpläche +Stirnflächen leicht gestrahlt 36 x 15 cm	6	100	*98.00
grau, Trittpläche +Stirnflächen grob gestrahlt 0-16mm, 36 x 15 cm	6	100	*98.00
grau, nur Trittpläche leicht gestrahlt 36 x 17 cm	6	113	*106.25
grau, Trittpläche + Stirnflächen leicht gestrahlt 36 x 17 cm	6	113	*112.00
Mehrpreis für braun, rot, gelb, anthrazit eingefärbt	Zuschlag +		18.00
Jurasplitt gelb sandgestrahlt 36 x 15 cm	6	100	*138.00

* nur auf Bestellung Spezialblockstufen auf Anfrage.

1.10 Stellriemen, Stellsteine, Abschlüsse

alle Preise exkl. MwSt

1.10.1 Stellriemen, Oberkante gerundet mit Nut und Kamm gepresst **D**

Grösse in cm	Farbe	Stk/Palette	CHF/Stk
100 x 20 x 5	grau	40	7.00
100 x 25 x 5	grau	30	6.80
100 x 30 x 5	grau	30	7.30
100 x 30 x 5	anth.	30	14.80



1.10.2 Stellriemen gerade grau, Oberkante 1-seitig gefast, gepresst **D**

Grösse in cm	kg	Stk/Palette	CHF/Stk
100 x 20 x 6	28	39	8.20
100 x 25 x 6	35	36	8.80
100 x 30 x 6	42	26	9.00
100 x 20 x 8	38	40	8.00
100 x 25 x 8	46	30	8.60
100 x 30 x 8	58	30	9.80
100 x 40 x 8	76	16	16.00
100 x 50 x 8	95	8	38.00
100 x 25 x 10	58	24	16.00
100 x 30 x 10	72	24	17.00
100 x 40 x 10 (nur auf Bestellung)	94		* 38.00



1.10.3 Stellriemen grau, gegossen, glatt, **+** beidseitig gefast, unarmiert

passend zu Winkelplatten (annähernd)

Grösse in cm	kg	Stk/Palette	CHF/Stk
100 x 25 x 4	25	20	22.20
100 x 30 x 4	30	20	23.20
100 x 40 x 4	40	20	28.30
150 x 30 x 4	44	20	35.50
200 x 30 x 4	60	20	94.40
100 x 25 x 5	31	17	23.55
100 x 30 x 5	37	17	24.40
100 x 40 x 5	50	17	33.00
100 x 50 x 5	60	17	47.00
100 x 25 x 6	37	14	30.50
100 x 30 x 6	45	14	32.80
100 x 40 x 6	60	14	37.00
100 x 50 x 6	72	14	55.60
100 x 25 x 8	48	11	36.40
100 x 30 x 8	60	11	37.95
100 x 50 x 8	96	11	59.40
100 x 30 x 10	75	10	51.00
100 x 30 x 12	90	7	65.00
100 x 40 x 12	120	7	73.00
100 x 46 x 12	132	7	76.00



Mach's dir bequem mit dem Micro-Drip-System

Einfache, nachhaltige Tropfbewässerung für deinen ganzen Garten!

www.gardena.com



WASSERSPARENDE
TROPFBEWÄSSERUNG



BEQUEM &
ZEITSPAREND



GESÜNDERE
PFLANZEN



FÜR GÄRTEN UND
TERRASSEN JEDER
GRÖSSE

alle Preise exkl. MwSt

1.10.4 Betonstellriemen mit Gummiabdeckung

Grösse in cm	kg/Stk	Gummi schwarz CHF/Stk
100 x 25 x 6	30	58.00
100 x 30 x 6	36	62.00



1.10.5 Randsteine ohne Vorsatz LP

12-15 x 30 x 100 cm (RB 15/30)	kg/lfm	Stk/Pal	CHF/Stk
	100	12	19.00



1.10.6 Bordsteine

grau, gegossen, scharfkantig	kg/Stk	Stk/Pal	grau CHF/Stk	anthrazit CHF/Stk
100 x 10 x 10 cm	24	40	24.10	34.20



1.10.7 Bundsteine gepresst, beidseitig gefast

Grösse in cm	kg/Stk	Stk/Pal	CHF/Stk
10 x 12 x 50	14	80	8.75



1.10.8 Betonbretter/Palisadenwandbretter
armiert, grau
(Auf Anfrage auch andere Farben und Strukturen)

Grösse in cm		Gewicht kg	CHF/Stk
180 x 40 x 7	scharfkantig	120	110.80
217 x 36 x 6	scharfkantig	108	110.80
200 x 50 x 6	scharfkantig, 1 Sichtfläche abgerieben	150	225.60
280 x 36 x 6	scharfkantig	140	166.90



1.10.9 Beeteinfassung / Rasenkante «Rite-Edge»,
aus Aluminium, 2,44 m lang,
(inkl. 2 Alu-Spieße pro Schiene)

Höhe in cm	Stärke	Farbe	Stück/Karton	Kartonweise CHF/Stk	einzel CHF/Stk
10	3 mm	Alu natur	14	29.70	33.00
14	5 mm	Alu natur	10	56.00	59.50
10	3 mm	Alu braun	14	38.00	41.00



www.spaeth-shop.ch

BAUMATERIAL SPÄTH
Bau- und Gartenbedarf

Gartenbedarf

alle Preise exkl. MwSt

1.10.10 FlexiLine Premium Alu-Rasenkanten (so lange Vorrat) mit glatter Stirnseite und frei platzierbare Erdnägel zur Befestigung im Boden (3 pro Stk.)

	Länge	Höhe	Stärke	Min. Radius	CHF/Stk
FlexiLine P blank	2,3 m	100 mm	5 mm	0,75 m	49.80



1.10.11 AluKante schlichte, robuste Abgrenzung für Belagsflächen, ideal für kurvige oder gerade Verläufe

	Länge	Höhe	Breite	Stärke	Min. Radius	CHF/Stk
AluKante	2,5 m	25 mm	32 mm	5 mm	0,75 m	49.95
	2,5 m	40 mm	45 mm	5 mm	0,75 m	66.75
	2,5 m	50 mm	45 mm	5 mm	0,75 m	73.00
	2,5 m	65 mm	45 mm	5 mm	0,75 m	76.50
	2,5 m	75 mm	70 mm	5 mm	0,75 m	88.00
	2,5 m	100 mm	70 mm	6 mm	0,75 m	102.00
	2,5 m	120 mm	70 mm	6 mm	1,00 m	* 121.00
	2,5 m	150 mm	70 mm	8 mm	1,50 m	119.80
Verbindungsstück	25-40 mm					1.65
	50-150mm					1.98

* nur auf Bestellung, so lange Vorrat



1.10.12 Randeinfassungen / Abgrenzungen «Ferrokante», rostend (Tora-Stahl)

Aus Stahl, (rostend) mit Ausstanzungen an Rückseite zum Verbinden und befestigen im Boden mittels mitgelieferter Erdnägel (3 Stk pro Einfassung), minimaler Biegeradius 2,50 m

Höhe in mm	Materialstärke in mm	Länge in m	CHF/Stk
100	3,0	2,0	42.00
150	3,0	2,0	77.50



alle Preise exkl. MwSt

1.10.13 Breitflachstahl S235JR schwarz

Beet-/Randeinfassungen, Kanten geschnitten

Höhe mm	Stärke mm	Länge cm	CHF/Stk
120	6,0	300	38.00
150	6,0	300	45.00
200	6,0	300	59.00
250	6,0	300	69.00
300	6,0	300	88.00



1.10.14 Uniprofile VF/Kiesleisten

	HxBxStärke	VE	Art. Nr.	CHF/Stk
UP-VF, extra stabil, Alu natur, 2,0 m	40x140x2mm	1	738 604	87.00
	60x140x2mm	1	738 606	94.00
	80x140x2mm	1	738 608	105.00
	100x140x2mm	1	738 610	110.00
UP-V, Innenverbinder, Alu natur	40mm x 2mm	1	738 724	11.20
	60mm x 2mm	1	738 726	12.10
	80mm x 2mm	1	738 728	13.50
	100mm x 2mm	1	738 730	14.90
UP-EA, Aussenecke, Alu natur	40mm x 2mm	1	738 744	41.00
	60mm x 2mm	1	738 746	42.00
	80mm x 2mm	1	738 748	43.00
	100mm x 2mm	1	738 750	45.00
UP-A, Uni-Abdeckprofil, Alu natur, Sichtkantenüberdeckung unter Uniprofile 2,0 m	20/40/12	1	738 510	51.00
	UP-AE Ecken	1	738 530	36.00
WP, Winkelprofil VF 2,0 m	35/50mm	20	738 412	43.00
	70/90mm	10	738 414	65.00
WP-V, Verbinder	35/50 mm	10	738 425	2.90
	70/90mm	10	738 429	3.20
WP-EA, Ecke Aussen	35mm x1,0mm	1	738 444	19.00
	50mm x1,0mm	1	738 445	20.00
	70mm x1,0mm	1	738 447	21.00
	90mm x1,0mm	1	738 449	23.00

1.11 Rasenkantensteine

Rasenkantenstein 	Stk./Pal.	grau CHF/Stk.	farbig CHF/Stk.
30 x 15 x 5 cm	280	2.20	2.60
24 x 12 x 4,5 cm	420	1.80	2.20



alle Preise exkl. MwSt

1.12

1.12.1 Paradiso-Böschungsteine	Stk./Pal.	Grösse cm	Farbe	kg/Stk	CHF/Stk
Paradiso gross	30	48 x 43 x 30	grau	44	8.00
Paradiso gross	30	48 x 43 x 30	braun	44	8.20
Paradiso klein	54	35 x 28 x 20	grau	17	4.50
Paradiso klein	54	35 x 28 x 20	braun	17	4.70



1.12.2 U-Steine klassisch	Stk./Pal.	Grösse cm	kg/Stk	CHF/Stk
steingrau	24	30 x 40 x 30	38	18.00
	12	40 x 50 x 40	80	25.00



1.12.3 Abschrankungssockel gegossen, vibriert, neu unarmiert	kg/Stk	CHF/Stk
60 x 60 x 40 cm	340	260.00
Ø 60 x 48 cm	325	325.00
Ø 45 x 45 cm	170	255.00



1.13 Winkelplatten

1.13.1 Winkel-L-Stein grau, nicht armiert	Stk./Pal.	Gewicht kg/Stk	CHF/Stk
H x B x T x D in cm			
40 x 40 x 22 x 6	32	33	21.00
50 x 40 x 26 x 6	24	44	23.00
60 x 40 x 32 x 6	16	57	26.00
80 x 40 x 40 x 6	18	78	34.00



alle Preise exkl. MwSt

1.13.2 Winkelplatten glatt (Roztec) grau, armiert, andere Grössen und Oberflächenstrukturen auf Anfrage	Höhe in cm	Stärke cm	50 cm breit CHF/Stk	100 cm breit Gewicht kg/Stk	100 cm breit CHF/Stk
25	5	72.00	60	116.00	
30	9	81.50	109	137.00	
40	5	85.50	79	143.00	
50	9	99.50	152	150.00	
55	5	95.50	100	146.00	
75	9	117.00	230	188.00	
100	9	162.00	315	262.00	
125	9-18	197.00	557	326.00	
150	9-18	293.00	631	457.00	
175	9-18	328.00	714	540.00	



1.13.3 Eckelemente glatt (Roztec) grau	Höhe in cm	Stärke cm	Schenkel-länge cm	Gewicht kg	CHF/Stk
25	5	50/50	48	226.00	
30	9	50/50	90	250.00	
40	5	50/50	64	261.00	
50	9	50/50	136	326.00	
55	5	50/50	83	297.00	
75	9	50/50	174	389.00	
100	9	100/100	560	540.00	
125	9-18	100/100	933	610.00	
150	9-18	100/100	1042	915.00	
175	9-18	100/100	1130	995.00	

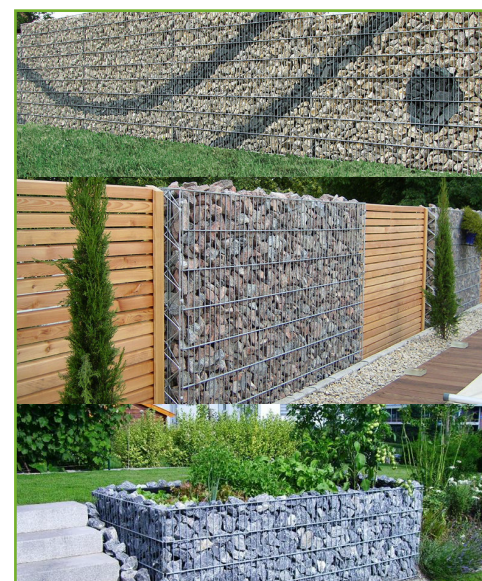

arcadia®

PERGONE®
die filigrane Gabionenwand
erhältlich
in 23 cm, 16 cm oder 13 cm Breite
und bis max. 240 cm Höhe

Hochbeet / mobiles Hochbeet
ertragreiche Ernte durch günstiges Kleinklima

L-TEC Winkelplatten

Der Massstab in Sachen Qualität und Funktionalität

AUS-BALANCIERT
für rationelles Arbeiten

- Top Qualität, beidseitig Sichtbeton SB4
- umgekehrter Einbau zulässig
- Frost- & Tausalzfest XF4



Höhe	Baulänge 99 cm	Baulänge 49 cm	Baulänge 199 cm
55 cm	✓	✓	✓
80 cm	✓	✓	✓
105 cm	✓	✓	✓
130 cm	✓	✓	✓
155 cm	✓	✓	✓
180 cm	✓	✓	✓
205 cm	✓	✓	
230 cm	✓		
255 cm	✓	Aussenecke 90° 2-tlg, Baulänge 99 cm	
280 cm	✓		
305 cm	✓		
355 cm	✓		
405 cm	✓		



1.14 Mauerscheiben

L-Tec Winkelplatten, Sichtbetonqualität rundum kraftschonendes Handling, 100% gerade, kleine Fase, Expositionsklasse XF 4 Lastfälle A und B

Baulänge:	Höhe cm	H x FL x BL x D cm	kg	Stk/Pal	CHF/Stk.
49 cm	**55	55 x 30 x 49 x 12	100	8	60.00
	**80	80 x 45 x 49 x 12	155	8	92.00
	**105	105 x 60 x 49 x 12	210	8	118.00
	130	130 x 70 x 49 x 12	261	4	148.00
	155	155 x 85 x 49 x 12	316	4	182.00
	180	180 x 100 x 49 x 12	423	4	260.00
99 cm	205	205 x 115 x 49 x 12	504	4	318.00
	**55	55 x 30 x 99 x 12	204	4	109.00
	**80	80 x 45 x 99 x 12	317	4	155.00
	**105	105 x 60 x 99 x 12	429	4	190.00
	130	130 x 70 x 99 x 12	535	2	248.00
	155	155 x 85 x 99 x 12	648	2	300.00
	180	180 x 100 x 99 x 12	868	2	410.00
	205	205 x 115 x 99 x 12	1035	2	496.00
	230	230 x 125 x 99 x 12	1219	2	670.00
	255	255 x 140 x 99 x 12	1425	2	*795.00
	280	280 x 155 x 99 x 12	1725	2	*970.00
	305	305 x 165 x 99 x 12	1974	2	*1100.00
	355	355 x FL x 99 x 12	2680	2	*1525.00
	405	405 x FL x 99 x 12	2820	2	*1620.00
Aussenecke 90° Zweiteilig	55	55 x 99 x 99 x 12	366	2	312.00
	80	80 x 99 x 99 x 12	552	2	451.00
	105	105 x 99 x 99 x 12	724	2	602.00
	130	130 x 99 x 99 x 12	896	1	695.00
	155	155 x 99 x 99 x 12	1044	1	850.00
	180	180 x 99 x 99 x 12	1403	1	1269.00
	205	205 x 99 x 99 x 12	1510	1	*1550.00
	230	230 x 99 x 99 x 12	1762	1	*2480.00
	255	255 x 99 x 99 x 12	2020	1	*2718.00
	280	280 x 99 x 99 x 12	2340	1	*2965.00
	305	305 x 99 x 99 x 12	2622	1	*3150.00
	L-Tec light NEU Wandstärke 8 cm	55	55 x 30 x 99 x 8	136	4
80		80 x 45 x 99 x 8	211	2	157.00
105		105 x 60 x 99 x 8	286	2	216.00

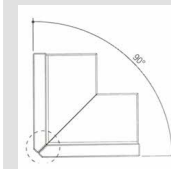
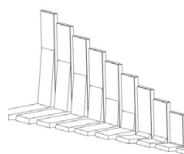
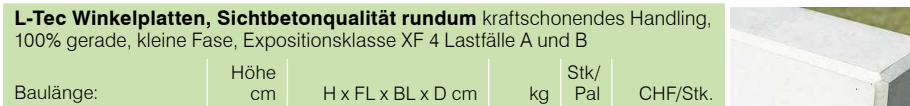

** Lastfälle A bis D * nur auf Bestellung Baulänge 199 cm nur auf Anfrage

Hebeschlaufen (wiederverwendbar) bis Höhe 155cm ab Höhe 180 cm	40.00 110.00
Kunststoffgleiter, Satz zu 10 Stk	15.50/Satz



➔ passende Stellriemen finden Sie unter 4.10.3

1.15 Betonpalisaden (Verfügbarkeit auf Anfrage)

1.15.1 Verbundpalisaden rund einseitig gekehlt



Länge in cm	Ø 20/17,5 cm hohl, grau		Ø 14/13 cm voll, grau	
	kg/Stk	CHF/Stk	kg/Stk	CHF/Stk
40	34	16.50	14	10.30
60	46	20.00	19	15.50
80	59	29.00	25	22.00
100	69	36.00	31	28.00
120 bewehrt	83	47.00	37	35.00
150 bewehrt	105	55.50		
180 bewehrt	121	82.00		
200 bewehrt	133	98.00		



1.15.2 Rechteckpalisaden Cubo

kubisch, geradlinig,
innen hohl, Beton roh



Dimension	Stk/ Pal.	Gewicht kg/Stk	steingrau (an Lager)		anthrazit	
			CHF/Stk	CHF/Stk	CHF/Stk	CHF/Stk
18x12 cm Länge 40 cm	48	21	13.00	14.50		
18x12 cm Länge 60 cm	48	34	18.00	19.50		
18x12 cm Länge 90 cm	24	48	29.70	31.00		
18x12 cm Länge 120 cm	24	63	49.00	55.00		
18x12 cm Länge 150 cm	24	79	58.00	73.00		



auf Bestellung auch gestrahlt achatgrau & sophistgrau lieferbar (Mehrpreis)



1.15.3 Mauerstein Bi-Muro gerumpelt, hinterfüllt bis 0,60 m, Wandstärke 25 cm, freistehend bis 1,20 m

Farben	Format cm	Stk/Palette	kg/Stk	CHF/Stk
schiefergrau, muschelkalk, juragraumix, hellgelb	37,5/25/20	24	43	19.70
	25/25/20	48	29	13.10
	50/25/10	42	29	13.10
	25/25/10	84	14	6.60



schiefergrau muschelkalk juragraumix hellgelb



1.15.4 Vino Mur Mauersteine mit bossierten Sichtflächen, Bedarf: ca. 19 Normalsteine / m² Maximale Mauerhöhe: 1,4 Meter



Farben	Format cm	kg/Stk	CHF/Stk
muschelkalk, titan	Normalstein 35/25/15	32	13.50
	grosser Endstein 25/25/15	23	12.95
	kleiner Endstein 10/25/10	9	9.40
	Abdeckplatte 35/33/6	17	29.80



muschelkalk titan



Gartenbedarf

alle Preise exkl. MwSt

1.15.5 Mauerabdeckplatten mit Wassernasen Beton-Abdeckplatten, grau, 60 cm lang

	Stk/Pal.	kg/Stk	CHF/Stk
Breite 25 cm für Mauer 15 cm	40	14	14.50
Breite 30 cm für Mauer 20 cm	40	17	16.00
Breite 35 cm für Mauer 25 cm	30	22,5	19.00
Breite 40 cm für Mauer 30 cm	30	26	21.00



Ausführung in anthrazit, beige, gelb und rot ab 1 Palette lieferbar Aufpreis: + ca 40 %

1.16 Blumen- und Brunnröge

1.16.1 Blumentröge rechteckig

Aussenmasse in cm (LxBxH)	Gewicht ca. kg/Stück	Zementgrau	Zementgrau
		Sichtbeton CHF/Stk	sandgestrahlt CHF/Stk
100 x 50 x 50	250	401.00	469.00
120 x 50 x 50	298	468.40	539.00
150 x 50 x 50	335	509.95	689.00
200 x 50 x 50	460	644.00	789.00
100 x 60 x 50	280	389.00	500.00
120 x 60 x 50	320	490.00	582.00
150 x 60 x 50	380	535.00	726.00
200 x 60 x 50	480	670.00	829.00
100 x 60 x 60	330	490.00	581.00
120 x 60 x 60	380	559.00	651.00
150 x 60 x 60	450	584.00	737.00
200 x 60 x 60	580	737.00	960.00



1.16.2 Blumentröge quadratisch

Aussenmasse in cm (LxBxH)	Gewicht ca. kg/Stück	Zementgrau	Zementgrau
		Sichtbeton CHF/Stk	sandgestrahlt CHF/Stk
50 x 50 x 50	150	246.00	289.00
60 x 60 x 50	190	269.00	323.00
60 x 60 x 60	230	359.00	450.00
80 x 80 x 60	335	559.00	648.00
100 x 100 x 50	400	670.00	782.00
100 x 100 x 60	450	713.00	825.00



Zuschläge: - Ausführung als Wassertrog mit Standrohr 1": + CHF 175.00
- Gegen Aufpreis auch eingefärbt erhältlich



Menschen. Formen. Swisspearl.

SWISSPEARL

Garten
2024

1.17





Swisspearl  Balcony	Länge cm	Breite cm	Ø cm	Höhe cm	Gewicht kg	Inhalt Liter	weiss CHF	anthrazit CHF	custom colors CHF
Balconia 	40 60 80 100	17		17	3,8 5,3 7,1 9,0	8,2 13,6 18,4 23,0	24.05 28.68 34.23 38.85	28.68 34.23 38.85 45.33	- - - -
Balconia Decor (solange Vorrat) 	40 60 80 100	17		17	3,8 5,3 7,1 9,0	8,2 13,6 18,4 23,0	24.05 28.68 34.23 38.85	28.68 34.23 38.85 45.33	- - - -
Balconia Reservoir 	60	17		20	5,5	13,6	55.50	-	-
Balconia Untersatz 	43 63 83	20		3	1,3 2,0 2,9		15.73 17.58 20.35	17.58 22.20 24.05	- - -
Delta25 	80 100	25		25	13,5 15,3	35,0 45,0	98.98 110.08	110.08 121.18	- -
Delta25 Untersatz 	83 103	28		5,5 5,5	5,3 6,3		50.88 54.58	59.20 61.98	- -
							grau CHF		
Untersatz eckig 	30 40 45 62,5	30 40 45 62,5		4,5 5,0 5,0 5,0	1,5 2,0 2,2 3,0		54.58 72.16 118.41 131.36	70.31 93.43 136.91 153.56	80.48 106.38 159.11 177.61
Untersatz rund 			30 35 40 46 52 62,5	4,5 4,5 5,0 5,0 5,0 5,0	1,0 1,2 1,6 2,1 2,4 2,6		47.18 53.65 67.53 71.23 82.33 118.41	55.50 71.23 78.63 85.11 95.28 136.91	65.68 81.41 89.73 98.98 106.38 159.11

Swisspearl Planter	Länge cm	Breite cm	Ø cm	Höhe cm	Gewicht kg	Inhalt Liter	grau CHF	anthrazit CHF	custom colors CHF
Delta35 	80 100	30 30		35 35	20,0 22,0	65,0 85,0	281.22 356.15	315.45 396.85	374.65 471.79
Delta45 	60 80 100 120 140	45 45 45 45 45		45 45 45 45 45	23,0 29,0 33,0 38,0 45,0	110,0 140,0 180,0 200,0 260,0	292.32 376.50 462.53 549.49 621.65	327.47 419.06 525.44 617.02 691.95	388.53 500.46 612.40 730.80 825.16
Delta60 ** 	80 100 120 140	55 55 55 55		60 60 60 60	40,0 46,0 53,0 61,0	265,0 330,0 396,0 440,0	497.69 563.37 660.50 778.91	553.19 648.47 740.98 844.59	659.57 746.53 876.97 1032.38
Delta45 	45 60 80 100	45 60 80 100		45 45 45 45	18,0 27,0 38,0 53,0	80,0 120,0 260,0 420,0	252.54 300.65 473.64 691.03	290.47 382.98 592.97 863.09	335.80 442.18 688.25 1001.85
Delta60 ** 	60 80 100	60 80 100		60 60 60	35,0 46,0 66,0	180,0 380,0 570,0	462.53 553.19 741.91	519.89 691.95 932.47	612.40 802.96 1079.56
Trenta-3 	33	33		66	9,0	60,0	246.07	354.30	420.91
Twista 	60	30		60	19,0	85,0	256.24	362.63	431.08

** mit Überlauf

Gartenbedarf

alle Preise exkl. MwSt

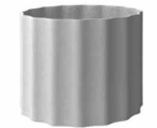
Swisspearl Planter	Länge cm	Breite cm	Ø cm	Höhe cm	Gewicht kg	Inhalt Liter	grau CHF	anthrazit CHF	custom colors CHF
Sessanta-6 	66	33		66	13,0	120,0	307.12	399.63	473.64
Delta45 			50 75 100	45 45 45	16,5 27,5 42,0	88,0 185,0 330,0	273.82 496.76 566.14	342.28 617.02 710.45	395.93 713.23 823.31
Delta60 ** 			75 100	60 60	33,0 45,0	265,0 471,0	694.73 741.91	772.43 892.69	921.37 980.57
Alto 			* 39/26 * 42/26 45/26	55 65 75	10,0 12,0 14,0	39,0 51,0 63,0	239.55 312.67	258.12 292.48 348.75	413.51
Hive 		neu neu	63,4 80 100,9	55,5 70 88,3	22,0 39,0 64,0	310	481.04 665.12 -	555.04 802.96 1155.41	670.68 931.54 1364.48
Kolonna 			60 60 80	50 60 70	16,0 18,0 35,0		359.85 402.41 579.09	501.39 548.57 748.38	581.87 636.45 867.72

alle Preise exkl. MwSt

Swisspearl Planter	Länge cm	Breite cm	Ø cm	Höhe cm	Gewicht kg	Inhalt Liter	grau CHF	anthrazit CHF	custom colors CHF
Aladin ** 			112 138 *168	59 73 87	75,0 125,0 145,0	400 690 1200		1876.04 3361.70 5577.24	2230.34 3998.15 6634.60
Bonsai ** 			112 138 165	40 50 60	33,0 50,0 86,0	350,0 620,0 1050,0		1197.96 2238.67 3629.97	1424.61 2659.57 4312.67
Lausanne 			70 90	23 30	10,0 20,0	65,0 120,0	265.49 339.50	352.45 383.90	417.21 456.06
Biasca 	93	93		32	20,2	31,0	230.34		306.20
Spindel 			37 56	60 92	9,0 26,5	7,0 20,0	257.17 337.65	*235.84	342.28 447.73
Quadra * 	36 38	36 38		65 75	13,0 15,0	53,0 62,0	212.63 266.48	239.55 286.91	
Wave * 	57	34		57	15,0	94,0		328.69	

* nur solange Vorrat ** mit Überlauf

alle Preise exkl. MwSt



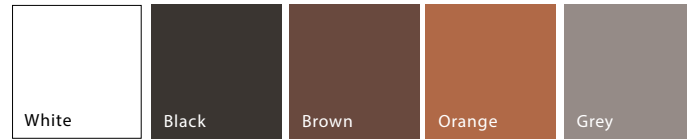

Expression - fünf eleganten Farbtöne erhältlich.
Matte Ausführung mit der rauen Haptik des naturbelassenen Werkstoffs.



Natural Colors - Drei sanfte, nicht deckende Farben bringen die Faserzement-Struktur besonders schön zur Geltung. Sie wirken frisch und modern und sind ein dezentes Statement.



Swisspearl Planter	Länge cm	Breite cm	Ø cm	Höhe cm	Gewicht kg	Inhalt Liter	Grau CHF	anthrazit CHF	expression/natural CHF	custom colors CHF
Maia		neu	35,4	50	5,9		184.09	221.09	233.12	244.22
			47,2	40	12	48	275.67	330.25	346.90	360.78
			59	50	15	96	323.77	391.30	409.81	427.38
Kyoto			35	36	12,5	23,0	185.01	209.07	222.02	243.29
			44	45	14,5	50,0	219.24	242.37	262.72	288.62
			53	55	16,0	90,0	260.87	283.07	313.60	345.05
			70	54	20,0	160,0	426.46	469.94	511.56	562.44
			90	70	53,0	400,0	716.00	790.93	860.31	946.35
			120	90	88,0	950,0		1691.95	1832.56	2015.73
Kyoto low			44	36	7,5	40,0	217.39	241.44	261.79	287.70
			53	40	12,5	70,0	252.54	282.15	304.35	334.88
			70	45	17,5	150,0	387.60	418.13	465.31	512.49
			90	50	46,0	280,0	713.23	790.01	855.69	941.72
			120	65	80,0	650,0		1611.47	1795.56	1975.95
Osaka			35	35	12,5	29,0	184.09	203.52	220.17	242.37
			44	44	14,5	60,0	230.34	252.54	275.67	303.42
			53	53	16,0	105,0	272.90	299.72	327.47	359.85
			70	70	54	27,0	428.31	475.49	514.34	565.22
			90	90	70	60,0	741.91	820.54	889.92	978.72
			106	36	24,0	90,0	462.53	509.71	554.12	609.62

alle Preise exkl. MwSt

Swisspearl Planter	Länge cm	Breite cm	Ø cm	Höhe cm	Gewicht kg	Inhalt Liter	Grau CHF	anthrazit CHF	expression/natural CHF	à la carte CHF
Osaka low										
	44	44		36	8,5	50	226.64	251.62	272.90	299.72
	53	53		40	14,5	70	265.49	299.72	319.15	351.53
	70	70		45	24,0	150	426.46	476.41	511.56	562.44
	90	90		50	50,0	280	733.58	819.61	879.74	967.62
Sumo	Ø cm	mitte	oben							
	49.5	35	40	12,5	40,0		234.04	260.87	280.30	308.05
	56.2	45	50	14,5	77,0		292.32	324.70	351.53	386.68
Tokyo *										
	44	44		45	10,0	45,0			221.91	
	53	53		55	19,0	80,0	248.84	309.19		
	70	70		40	16,0	70,0	322.19	355.62		
	53	53		5,5	1,4		114.21	132.78		
Geisha										
			44	65	13,0	85,0	292.32	335.80	352.45	387.60
Samurai										
	44	44		65	16,0	95,0	303.42	336.73	363.55	400.56
Ronco										
			57,2	44	14		323.77	456.06	481.04	529.14
			70,2	54	21		463.46	590.19	621.65	684.55
Sushi *										
			50	50	17,0	70,0		329.62		
			65	65	30,0	180,0		504.18		

* nur solange Vorrat

alle Preise exkl. MwSt

1.17.2 Swisspearl Living - DIE BANK	Farbe*	Gewicht	CHF/Stk.
Grösse 160 x 45 x 46 cm	anthrazit	50 kg	1037.00



1.17.3 Swisspearl Living - PORTO grau	Gewicht	CHF/Stk.
Porto Table, 71 x 23 cm	9 kg	322.85
Porto Side Table, 46 x 23 cm	6 kg	247.92
Porto Stool, 36 x 42 cm	6,5 kg	313.60



1.17.4 Swisspearl Living - DUNE	Masse cm	Gewicht	anthrazit CHF/Stk.	titan* CHF/Stk.
Dune center	96 x 95 x 60	48 kg	950.97	950.97
Dune left	96 x 95 x 60	48 kg	950.97	950.97
Dune right	96 x 95 x 60	48 kg	950.97	950.97
Dune table	96 x 89 x 36	44 kg	720.63	720.63

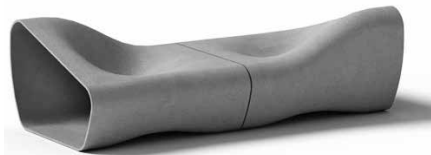

* auch in "Custom Colors" erhältlich

1.17.5 Swisspearl Living - CHEERS Weingestell	Stk/Pal	Masse cm	kg/Stk.	CHF/Stk.
grau	8	38 x 25 x 31	4,8	134.14



alle Preise exkl. MwSt

1.17.6 Swisspearl Living - GUHL	Stk/Pal	Masse cm	kg/Stk.	CHF/Stk.
Stuhl grau	2	79 x 54 x 61	11,5	960.22
Tisch grau	4	72 x 40 x 22	12	788.16

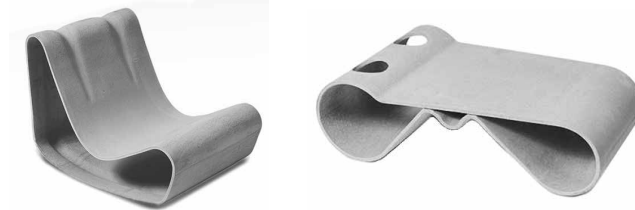

1.17.7 Swisspearl Living - ECAL	Stk/Pal	Masse cm	kg/Stk.	grau CHF/Stk.
Hocker	4	44 x 32 x 44	12	344.13
Tisch	3	70 x 49 x 27	20	450.51



1.17.8 Swisspearl Living - HOCUSPOCUS	Stk/Pal	Masse cm	kg/Stk.	grau CHF/Stk.
Tisch	2	45 x 43	20	199.81
Tisch gross	2	58 x 36	20	230.34

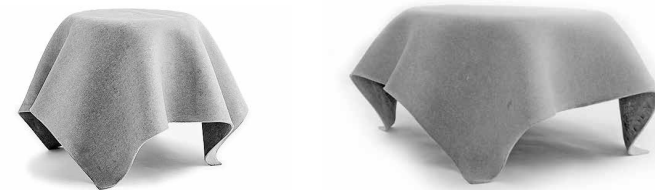

1.17.9 Swisspearl Living - SPONECK	Stk/Pal	Masse cm	kg/Stk.	grau CHF/Stk.
Sessel	2	77,5 x 50 x 60	28	789.08
Tisch	2	50 x 50 x 25	21	518.04



alle Preise exkl. MwSt

1.17.10 Relax Liege Siesta
Eukalyptusholz/Fichte, hochwertige Handwerkerqualität, integrierte Räder, Farbe natur, unbehandelt/lasiert, fertig montiert

	CHF/Stk.
180x90 cm	1120.00
180x140 cm	1350.00



1.17.11 Garnitur Luzern
Fichte gehobelt, KDI grün, Gewicht: 200 kg, fertig montiert

	CHF/Stk.
200x75x180 cm	1200.00



1.17.12 Festgarnitur
Tisch 80cm mit 2 Bänken
Produziert in der Schweiz mit Schweizer Holz

	netto CHF/Stk.
220x80 cm	211.68



1.17.13 Eichenkübel  aussen lackiert

	Höhe in cm.	CHF/Stk.
30 cm Ø	27	76.00
35 cm Ø	32	94.00
40 cm Ø	37	119.70
45 cm Ø	42	144.20
50 cm Ø	45	174.50
60 cm Ø	50	263.30
60 cm Ø *	55	322.00
65 cm Ø *	60	391.00
70 cm Ø *	65	460.00
75 cm Ø *	70	625.00
80 cm Ø *	70	870.00
90 cm Ø *	80	1255.00
100 cm Ø *	90	1470.00



* schwere Ausführung, aussen geschliffen und am unteren Rand mit Aussparungen

1.17.14 Terracotta Gefässe aussen
Handgefertigten Gefässe aus Italien, winterfest

	Masse (Aussen!)	Höhe/cm.	CHF/Stk.
Conca Liscia	70 cm Ø	59	304.34
	60 cm Ø	50	174.84
	54 cm Ø	46	147.08
	48 cm Ø	40	100.83
	42 cm Ø	36	82.33
	36 cm Ø	30	63.83
Conca Toscana	70 cm Ø	57	304.34
	60 cm Ø	48	174.84
	54 cm Ø	44	147.08
	48 cm Ø	39	100.83
	42 cm Ø	34	82.33
	36 cm Ø	29	63.83
Cilindro	70 cm Ø	48	324.05
	62 cm Ø	45	248.84
	55 cm Ø	38	137.83
	50 cm Ø	31	100.83
	40 cm Ø	25	82.33
Conca Alta	55 cm Ø	75	304.34
	45 cm Ø	65	193.34
	35 cm Ø	55	165.58
Unterset-Füsse (4er Set)	13x9x3 cm		12.95



alle Preise exkl. MwSt



**ORIGINAL
EVERBAG**

Allzweckbehälter EVERBAG, schwarz
Das Original.
Neu mit doppeltem Boden







70 Liter	D 45 cm	CHF 46.33
130 Liter	D 55 cm	CHF 50.97
215 Liter	D 65 cm	CHF 55.61

1.18 gartensilber Pflanzgefässe

gartensilber Pflanzgefässe, isoliert Handwerklich gefertigte Metallpflanzgefässe, KTL- und pulverbeschichtet. Bodenfreiheit durch Füsse/verdeckte Rollen- somit höchsten ästhetischen Ansprüchen entsprechend.

Standardfarben:

Strukturlack matt: anthrazit/silber/marone/weiss/jadegrün
 Glattlack glanz: weiss/rubinrot/grau/anthrazit/schwarz

	Länge cm	Breite cm	Ø cm	Höhe cm	Gewicht kg	anthrazit CHF
Kubus						
	40	40		40	18	462.00
	45	45		45	23	561.00
	50	50		50	27	616.00
	55	55		55	33	726.00
	60	60		60	41	858.00
	65	65		65	46	935.00
	70	70		70	52	1012.00
Säule						
	40	40		90	42	847.00
	45	45		100	48	940.00
Quader						
	90	40		40	32	836.00
	100	45		45	42	940.00
Aufpreis Rankgerüst						+ 320.00
Quader hoch						
	90	40		70	53	1078.00
Sichtschutzquader						
	150	50		50	30	2700.00
mit Stoffbespannung neu						
	150	42		80	61	2920.00
Alu mit Holzschutz nur ohne Rollen Höhe gesamt: 190 cm						
Rollensatz, verdeckt montiert						106.00



1.18.1 Wasserfall	Länge cm	Breite cm	Höhe cm	CHF
Alu, pulverbeschichtet, Speier aus Edelstahl	140	70	30/85	3350.00
Pumpe passend zu Brunnen und Wasserfall: Oase, Aquarius Universal Eco 3000, 230 V				351.90

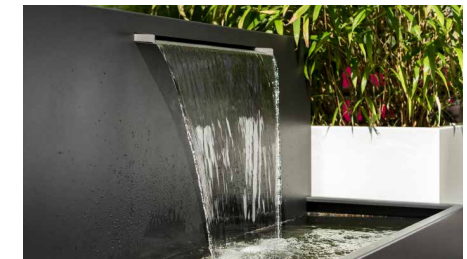

1.19 Teichfolien

Teichfolien		Offenverkauf CHF/m ²	ganze Rolle CHF/m ²
PVC Teichfolie 1,0 mm	Rolle: 4 / 6 / 8 / 10 x 20 m	15.50	9.95
EPDM-Teichfolien 1,02 mm	Rolle: 4,26 / 6,1 / 9,15 x 30,5m 12,20 / 15.25 x 30,5 m *	21.00	14.90

* auf Bestellung innert 2 Tagen



1.20 Pfähle

1.20.1 Pfähle zylindrisch gefräst, gespitzt, druckimprägniert Kdi, grün

Ø in cm	Länge cm	Stk/Palett	palettweise CHF/Stk	einzel CHF/Stk
3	125		2.80	3.00
3	175	432	4.40	4.87
4,5	100	205	2.78	3.10
4,5	125	205	3.55	3.96
4,5	150	205	4.25	4.75
4,5	200	205	5.40	5.80
6	60	100	2.50	2.90
6	125	100	6.00	6.50
6	150	100	5.80	6.45
6	175	100	6.60	7.30
6	200	100	7.75	8.59
6	250	100	9.60	10.67
7	300	100	11.40	12.60
7	350	100	17.00	18.90
7	400	100	18.80	21.00
8	75	108	4.60	5.10
8	200	108	12.00	13.40
8	250	108	15.00	16.25
8	300	108	16.80	18.52



1.20.2 Pfähle zylindrisch gefräst, gespitzt, druckimprägniert Kdi, braun

7	100	100	5.45	6.04
7	125	100	6.50	7.20
7	150	100	7.30	8.12
7	175	100	8.33	9.24
9	150	100	12.10	13.46
9	175	100	14.17	15.74
9	200	100	15.00	16.67

1.20.3 Pfähle gefräst, gespitzt, unbehandelt, roh

4,5	100	205	2.50	2.77
4,5	125	205	3.14	3.48
4,5	150	205	3.75	4.16
4,5	175	205	4.38	4.84
4,5	200	205	5.00	5.50
6	125	100		5.30
6	175	100	6.00	6.60
6	200	100	6.85	7.55
7	200	100	8.90	9.80
7	250	100	11.00	12.25
7	300	100	13.25	14.70
7	350	100	15.45	17.15

1.20.4 Akazienpfähle gespitzt

	Stk/Palette	CHF/Stk
Akazienpfosten gesägt, 4 / 4 / 50 cm	100	2.30
Akazienpfosten gesägt, 4 / 4 / 75 cm	100	3.30
Akazienpfosten gesägt, 4 / 4 / 100 cm	100	4.30
Akazienpfosten gesägt, 4 / 4 / 125 cm	100	5.60
Akazienpfosten gesägt, 150 / 6 / 6 cm	100	13.00
Akazienpfosten gesägt, 175 / 6 / 6 cm	100	15.00
Akazienpfosten gesägt, 200 / 6 / 6 cm	100	17.90
Akazienpfosten gesägt, 8 / 10 / 125 cm	50	26.40
Akazienpfosten gesägt, 8 / 10 / 150 cm	50	31.50
Akazienpfosten gesägt, 8 / 10 / 175 cm	50	36.10
Akazien-Dreikantpfähle 8-10 x 150 cm	100	12.30
Akazien-Dreikantpfähle 8-10 x 175 cm	100	14.30
Akazien-Dreikantpfähle 8-10 x 200 cm	100	16.50
Akazien-Rundpfähle geschält 6-8 x 150 cm		9.80
Akazien-Rundpfähle geschält 8-10 x 200 cm		21.00
Akazien-Rundpfähle geschält 8-10 x 250 cm		28.00



1.20.5 Vierkantpfosten mit Spitz, druckimprägniert, Kdi, braun

Masse in cm	Stk/Palette	palettweise CHF/Stk	einzel CHF/Stk
7 x 9 x 100 gehobelt, gefast	100	16.00	17.25
7 x 9 x 125 gehobelt, gefast	50	19.90	21.60
7 x 9 x 150 gehobelt, gefast	50	24.00	26.00
10 x 10 x 125 gehobelt, gefast, Lärche	50	33.00	34.80
10 x 10 x 150 gehobelt, gefast, Lärche	50	39.20	41.30
10 x 10 x 175 gehobelt, gefast, Lärche	50	45.10	47.50



1.21 Holzpalisaden

Holzpalisaden, druckimprägniert, Kdi (grün) Zylindrisch gefräst, Kopf gefast	Stk/Palette	CHF/Stk
Länge in cm		
75	64	9.90
100	64	14.70
125	64	18.00
150	64	21.60
175	64	25.30
200	64	28.90
250	64	35.80
300	64	43.00
400	45	58.60
500	45	76.80





biohort®



BAUMATERIAL SPÄTH
AUSSTELLUNG



Bei uns bekommen Sie Gerätehäuser, Boxen & mehr in Bestform



alle Preise exkl. MwSt

1.22 Kantholzpfosten

Kantholzpfosten, Konstruktionsholz druckimprägniert, Kdi, gehobelt, gefast (weitere Grössen auf Anfrage)	Farbe	Stk/Palette	palettwewe CHF/Stk	einzel CHF/Stk
Masse in cm				
9 x 9 x 180	grün	156	17.30	18.46
9 x 9 x 210	grün	39	22.00	23.04
9 x 9 x 240	grün	39	24.80	25.80
9 x 9 x 270	grün	39	29.40	30.44
9 x 9 x 300	grün	39	30.50	32.28
7 x 7 x 180	grün	51	11.00	11.98
7 x 7 x 210	grün	51	13.20	14.34
7 x 7 x 240	grün	51	15.00	16.19



1.23 Druckimprägnierte Bretter

Druckimprägnierte Bretter Fichte, chromfrei, Kdi grünlich	Masse cm	Stk/Paket	paketweise CHF/Stk	einzel CHF/Stk
Bretter sägerauh	3 x 20 x 500	52	44.00	48.00
	3 x 25 x 500	52	58.00	62.70
	3 x 28 x 500	52	68.00	72.50
	4,5 x 25 x 500	52	99.00	116.00



1.24 Halbrundlatten

Zaunriegel, druckimprägniert, chromfrei	Stk/Palette	braun CHF/Stk	grün CHF/Stk
8 x 250 cm	65	8.09	
8 x 500 cm	100	25.90	23.90
10 x 500 cm	105	33.90	32.30
12 x 500 cm	105		43.50
unbehandelt, roh natur			
8 x 500 cm	105		21.00
10 x 500 cm	105		26.50



1.25

Neue Eichenschwellen A, unbehandelt nicht gehobelt!	Länge m	kg Stk.	bundweise (20/Bund) CHF/Stk	einzel CHF/Stk
Breite x Höhe in cm				
14 x 24	2,6	83	79.00	86.00
14 x 24	1,3	42	53.00	57.00



1.26 Sichtschutz-Zäune

Dichtzaun Rhodos Kiefer, grünlich imprägniert, FSC, B x H	CHF/Stk
180 x 180 cm	79.00
180 x 150 cm	76.00
180 x 90 cm	59.00
150 x 180 cm	78.00
100 x 180 cm	62.00
90/90 x 180 cm	62.00
60 x 180/210 cm	74.00



1.27 Rankgitter diagonal Fichte/Tanne kesseldruckimprägniert grün, Maschenweite 12 cm, Leisten 12x30 mm	neogard	CHF/Stk
180 x 180 cm (B x H)		83.74
90 x 180 cm (B x H)		55.42

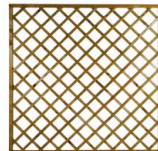

Weitere Sichtschutzzäune auf Bestellung, verlangen Sie unsere Kataloge!



1.28 Sichtschutzmatten

1.28.1 Schilfrohrmatten Saubere Qualität, als Sichtschutz oder Baumschutz verwendbar	CHF/Rolle
100 x 500 cm	31.70
150 x 500 cm	49.15
200 x 500 cm	64.50
240 x 600 cm	76.20



1.28.2 Weidenmatten «Rustikal»	CHF/Rolle
90 x 300 cm	64.00
150 x 300 cm	110.00
180 x 300 cm	127.00
200 x 300 cm	153.00



1.28.3 Bambusmatte «Beach» aus gespaltenen Bambus	CHF/Rolle
100 x 300 cm	37.04
150 x 300 cm	50.97
180 x 300 cm	67.75
200 x 500 cm	76.00



1.29 Sichtschutz Metall rostend

«Gräser» cm /CHF	
50 x 200	258.10
100 x 200	502.22

«Gras» cm /CHF	
100 x 200	481.90

«Blattwerk» cm /CHF	
50 x 200	285.85
100 x 200	406.10

«Allium» cm /CHF	
100 x 200	452.35

«Farn» cm /CHF	
100 x 200	489.36



Gräser

Gras

Blattwerk

Allium

Farn

ARBEITSKLEIDUNG VON ENGEL

X-TREME

1.30 Kastanien-Lattenzaun ^(F)		
Latten gespalten, gespitzt, natur unbehandelt	CHF/Stk	
Rolle 5 m lang		
Höhe 80 cm		179.00
Höhe 100 cm		195.00
Höhe 120 cm		235.00
Türe zu Kastanien-Lattenzaun ^(F)		
1 m breit, auf Rahmen aufgenagelt, inkl. Beschläge	CHF/Stk	
Höhe 80 cm		379.00
Höhe 100 cm		409.00
Höhe 120 cm		429.00



1.31 Draht

1.31.1 Eisendraht verzinkt	Rollen zu 1 kg	Rollen zu 2,5 kg	Rollen zu 5 kg
Ø in mm	CHF/Rolle	CHF/Rolle	CHF/Rolle
1,0	13.00	28.25	
1,6	11.60	25.50	46.75
2,0	11.50	25.00	44.75
2,5	11.30	24.75	44.25
3,0	11.20	24.00	43.50

1.31.2 Eisendraht verzinkt, plastifiziert	Länge m	CHF/Rolle
1,4 / 1,8 mm Ø grün plastifiziert / anthrazit	100	30.10
3,0 / 3,5 mm Ø grün plastifiziert	55	39.80
2,3 / 2,8 mm Ø grün plastifiziert, schwarz plastifiziert / anthrazit, ca. 5kg	150	73.00

1.31.3 Stacheldraht verzinkt	25 m/Rolle	100 m/Rolle
Ø in mm	CHF/Rolle	CHF/Rolle
1,7		52.90
2,2 / 2 Stachel	44.40	82.90

1.31.4 Drahtspanner	VE	verzinkt einzeln	CHF/Stk	grün/schwarz/anthrazit einzeln	CHF/Stk
Nr. 2	50	2.08	1.88	2.71	2.51
Nr. 3	50	2.79	2.59	3.34	3.14



1.32 Drahtgeflechte

1.32.1 Diagonaleflecht stark verzinkt, Rollen à 25 m Zaunhöhe in cm	Maschenweite/ Drahtstärke in mm	CHF/m ¹
60	50/2,5	5.32
80	50/2,5	6.77
100	50/2,5	8.32
120	50/2,5	9.93
150	50/2,5	12.42
180	50/2,5	14.92
200	50/2,5	16.58

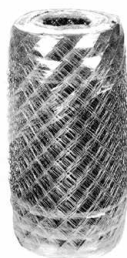

1.32.2 Diagonaleflecht plastifiziert, Rollen à 25 m Zaunhöhe in cm	Maschenweite/ Drahtstärke in mm	grün RAL 6005 schwarz RAL 9005 anthrazit RAL 7016 CHF/m ¹
60	50/2,3/2,8	8.56
80	50/2,3/2,8	11.00
100	50/2,3/2,8	13.45
120	50/2,3/2,8	16.06
150	50/2,3/2,8	20.05
180	50/2,3/2,8	24.04
200	50/2,3/2,8	26.65*



1.32.3 Knotengitter leicht, bezinal verzinkt, Rollen à 50 m Zaunhöhe in cm	Anz. Längsdrahte	CHF/m ¹
100	8	3.40
100	16	5.40
130	11	4.80
130	18	6.30
145	19	6.50
200	22	8.00



1.32.4 Knotengitter schwer, bezinalbeschichtet, Rollen à 50 m Zaunhöhe in cm	Anz. Längsdrahte	CHF/m ¹
80	8	7.70
100	6	7.40
100	10	9.30
120	7	9.00
120	11	10.80
140	12	11.90
180	14	11.00



HSB ZÄUNE CLÔTURES
TORE PORTAILS
SICHERHEIT SÉCURITÉ

hsb-bern.ch

1.32.5 Sechseckgeflecht verzinkt Zaunhöhe in cm	Maschenweite mm	Drahtstärke mm	Rollenlänge m	CHF/m ¹
50	25	0,8	25	2.20
100	13	0,7	25	6.20
100	20	0,7	25	4.20
150	20	0,7	25	6.60
100	25	0,8	25	4.00
200	50	1,0	50	5.30



Sechseckgeflecht grün plastifiziert Zaunhöhe in cm	Maschenweite mm	Drahtstärke mm	Rollenlänge m	CHF/m ¹
50	13	1,0	25	5.95
100	25	1,0	25	2.80

Sechseckgeflecht rostfrei Zaunhöhe in cm	Maschenweite mm	Drahtstärke mm	Rollenlänge m	CHF/m ¹
100	20	0,5	50	14.01

➔ **Hinweis:** Kein Offenverkauf.

alle Preise exkl. MwSt

1.32.6 Casanet-Drahtgitter verzinkt	Breite m	Länge m	Ø Draht mm	CHF/m ¹
Maschenweite in mm				
12,7 x 12,7	1,0	25	0,8	14.50
12,7 x 25,4	1,02	25	1,4	17.70



1.32.7 Pantanet-Gitter schwer	Länge m	anthrazit* tannengrün RAL 6005 CHF/m ¹
das grüne Gitter für einen soliden Zaun, formstabil Maschenweite 100 x 50 mm, Drahtstärke 2,0 / 2,5 mm		
Höhe in mm		
810	25	7.20
1020	25	8.60
1220	25	10.00
1520	25	12.10



* auf Bestellung auch in anthrazit RAL 7016 lieferbar

➔ **Hinweis:** Kein Offenverkauf.

1.32.8 Rohrpfosten	Pfostenlänge cm	für Zaunhöhe cm	Schl. und Schr.	verzinkt CHF/Stk.	anthrazit, grün od. schwarz (auf Bestellung) CHF/Stk.
(schwere Ausführung) mit Kunststoffkappe, rostfreien Schlaufen und Schrauben					
Ø Rohr					
33 mm – 1"	90	50	2	25.80	40.00
33 mm – 1"	100	60	2	29.40	44.60
33 mm – 1"	110	70	3	31.30	48.80
33 mm – 1"	120	80	3	32.20	51.20
33 mm – 1"	130	90	3	32.20	
33 mm – 1"	150	100	3	36.80	59.50
33 mm – 1"	170	120	3	41.40	67.00
42 mm – 5/4"	90	50	2	30.40	48.40
42 mm – 5/4"	100	60	2	34.00	53.90
42 mm – 5/4"	110	70	3	35.90	57.70
42 mm – 5/4"	120	80	3	* 37.70	61.40
42 mm – 5/4"	130	90	3	* 37.70	61.40
42 mm – 5/4"	150	100	3	* 44.20	72.50
42 mm – 5/4"	170	120	3	* 48.80	80.90
42 mm – 5/4"	200	150	4	* 55.20	92.10
42 mm – 5/4"	230	180	4	61.60	104.20
42 mm – 5/4"	250	200	5	66.20	112.60



alle Preise exkl. MwSt

Ø Rohr	Pfostenlänge cm	für Zaunhöhe cm	Schl. und Schr.	verzinkt CHF/Stk.	anthrazit, grün od. schwarz (auf Bestellung) CHF/Stk.
48 mm – 1 1/2"	120	80	3	* 44.20	71.60
48 mm – 1 1/2"	130	90	3	44.20	71.60
48 mm – 1 1/2"	150	100	3	* 52.40	85.60
48 mm – 1 1/2"	170	120	3	* 58.00	95.80
48 mm – 1 1/2"	200	150	4	* 65.30	109.70
48 mm – 1 1/2"	230	180	4	* 74.50	124.60
48 mm – 1 1/2"	250	200	5	* 79.10	144.20
60 mm – 2"	120	80	3	47.80	77.20
60 mm – 2"	130	90	3	47.80	77.20
60 mm – 2"	150	100	3	56.10	92.10
60 mm – 2"	170	120	3	61.60	102.30
60 mm – 2"	200	150	4	69.90	118.10
60 mm – 2"	230	180	4	* 78.20	133.90
60 mm – 2"	250	200	5	* 84.60	153.50

1.32.9 Rohrstreben	Strebenlänge cm	für Zaunhöhe cm	verzinkt CHF/Stk.	anthrazit grün od. schwarz (auf Bestellung) CHF/Stk.
(schwere Ausführung) mit Alu-Strebenspitze				
Ø Rohr				
33 mm – 1"	75	50	21.20	34.40
33 mm – 1"	90	60	23.00	39.10
33 mm – 1"	105	70	25.80	43.70
33 mm – 1"	120	80	* 27.60	47.40
33 mm – 1"	130	90	29.40	51.20
33 mm – 1"	140	100	* 31.30	53.90
33 mm – 1"	160	120	* 34.00	59.50
33 mm – 1"	200	150	* 48.80	71.60
42 mm – 5/4"	140	100	37.70	67.00
42 mm – 5/4"	160	120	41.90	79.40
42 mm – 5/4"	200	150	* 48.80	84.60
42 mm – 5/4"	230	180	* 55.20	94.90
42 mm – 5/4"	250	200	* 58.90	102.30



Rohrwandstärke: 2,65 bei Ø 33 mm – 1" / 2,65 bei Ø 42 mm – 5/4"

* Lagerartikel

alle Preise exkl. MwSt

1.32.10 Rohrtraversen
mit 2 Alu-Traversenspitzen

Ø Rohr	Traversenlänge cm	verzinkt CHF/Stk	anthrazit grün od. schwarz (auf Bestellung) CHF/Stk.
33 mm - 1"	100	33.10	52.10
33 mm - 1"	150	41.40	67.00
33 mm - 1"	200	* 48.80	81.80
33 mm - 1"	250	* 56.10	* 96.70
42 mm - 5/4"	100	36.80	62.30
42 mm - 5/4"	150	46.00	77.20
42 mm - 5/4"	200	56.10	99.50
42 mm - 5/4"	250	* 65.30	118.10
42 mm - 5/4"	300	74.50	136.70

1.32.11 Rohrpfosten auf Fussplatte
(schwere Ausführung) mit Kunststoffkappe, rostfreien Schlaufen und Schrauben, Fussplatte 100x100mm

Ø Rohr	Pfostenlänge cm	für Zaunhöhe cm	verzinkt CHF/Stk.	anthrazit grün od. schwarz (auf Bestellung) CHF/Stk.
42 mm - 5/4"	55	50	57.70	105.10
42 mm - 5/4"	65	60	62.30	111.60
42 mm - 5/4"	85	80	68.80	117.20
42 mm - 5/4"	105	100	* 74.40	123.70
42 mm - 5/4"	125	120	81.80	135.80
48 mm - 1 1/2"	125	120	95.60	153.50
48 mm - 1 1/2"	155	150	106.00	179.90
48 mm - 1 1/2"	185	180	119.00	196.20
48 mm - 1 1/2"	205	200	126.50	211.10

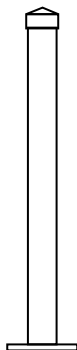

Rohrwandstärke: 2,65 bei Ø 42 mm - 5/4" / 2,90 bei Ø 48 mm - 1 1/2"

1.31.12 Rohrstreben auf Fussplatte (schwere Ausführung) mit Alu-Strebenspitze

Ø Rohr	Strebenlänge cm	für Zaunhöhe cm	verzinkt CHF/Stk.	anthrazit, grün, schwarz (auf Bestellung) CHF/Stk.
33 mm - 1"	51	50	56.70	99.50
33 mm - 1"	65	60	59.50	103.20
33 mm - 1"	93	80	69.80	113.50
33 mm - 1"	122	100	* 78.10	122.80
33 mm - 1"	147	120	82.80	142.30
42 mm - 5/4"	182	150	97.70	171.10
42 mm - 5/4"	223	180	107.90	198.10
42 mm - 5/4"	238	200	112.50	208.30

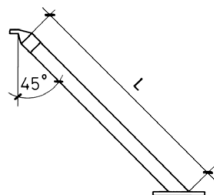

Rohrwandstärke: 2,65 bei Ø 33 mm - 1" / 2,90 bei Ø 48 mm - 5/4" * Lagerartikel

1.32.13 Türen einflügelig,
mit Diagonalgeflecht 50 x 2,5 mm bespannt, Rohrrahmen Ø 42 mm, Scharnier verstellbar, Öffnung über 180°, Drückerschloss mit Schlüssel oder Zylinderausschnitt und Schliesskasten, mit 2 Rohrpfosten Ø60 mm, ohne Streben

Breite cm	Höhe cm	Gewicht kg	feuerverzinkt CHF/ Stk.	anthrazit/ schwarz/grün (auf Bestellung) CHF/ Stk.
100	80	24	924.80	1175.60
	100	28	979.40	1262.40
	120	30	1013.20	1316.60
	150	37	1129.80	1504.20
	180	42	1196.20	1606.60
120	200	44	1244.00	1681.80
	80	26	954.80	1310.60
	100	29	1008.40	1378.90
	120	33	1042.20	1455.60
	150	39	1158.80	1632.20
180	44	1231.20	1722.60	
	200	47	1273.00	1822.00

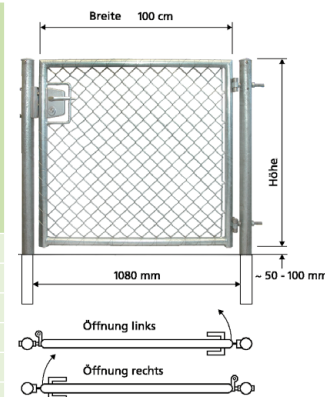

1.32.14 Türen zweiflügelig,
mit Diagonalgeflecht 50 x 2,5 mm bespannt, Rohrrahmen Ø 42 mm, mit Schloss und 2 Rohrpfosten Ø60mm

Auf Bestellung	Breite	Höhe cm	Gewicht kg	feuerverzinkt CHF/ Stk.	anthrazit/ schwarz/grün CHF/ Stk.
300cm (100cm+200cm)	80	53	2187.80	2662.90	
	100	61	2279.40	2805.00	
	120	63	2393.20	2945.40	
	150	79	2662.60	3347.00	
	180	87	2781.80	3524.00	
	200	92	2888.20	3647.00	

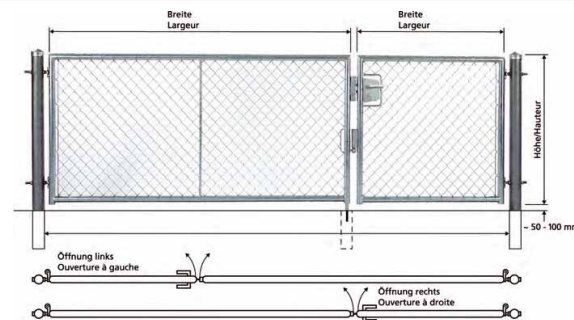

alle Preise exkl. MwSt

alle Preise exkl. MwSt

1.32.15

Doppelstabmatten Typ S schwer

Maschenweite 50x200 mm, senkrechter Stab +/- 6 mm, waagrechte Stäbe doppelt +/- 8 mm

Abmessung Breite x Höhe in mm	verzinkt CHF/Stk.	anthrazit CHF/Stk.
2500 x 830	76.10	73.70
2500 x 1030	* 92.80	* 82.80
2500 x 1230	* 110.00	* 97.00
2500 x 1430	127.10	111.20
2500 x 1630	134.80	125.40
2500 x 1830	146.80	139.90
2500 x 2030	163.20	* 154.50



Pfosten zu Doppelstabmatten Typ S schwer

Rahmen 60x40mm, mit Alu-Pfostenkappe und Kunststoffhalter, inkl. Flacheisenabdeckleiste und Schrauben

Länge mm	Zaunhöhe mm	verzinkt CHF/Stk.	anthrazit CHF/Stk.
1300	830	50.50	47.50
1600	1030	57.90	64.20
1800	1230	* 65.70	* 72.80
2000	1430	* 73.60	* 81.50
2200	1630	81.10	89.80
2400	1830	88.70	98.20
2600	2030	96.20	* 106.50

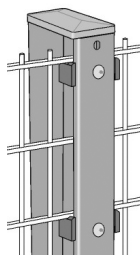

Türe zu Doppelstabmatten Typ S schwer

Rahmen 60x40mm inkl. Pfosten-, Alu-Drückergarnitur, Locinox-Einsteckschloss, beidseitiger Zaunanschluss, Edelstahlwinkel-Masse (BxH) mm

Masse (BxH) mm	verzinkt CHF/Stk.	anthrazit CHF/Stk.
1000 x 800	713.00	882.00
1000 x 1000	750.00	941.00
1000 x 1200	773.00	977.00
1000 x 1400	851.00	1104.30
1000 x 1600	902.00	1179.00
1000 x 1800	915.00	1191.00
1000 x 2000	958.00	1253.00



* Lagerartikel • 1 Woche Lieferfrist

Andere Grössen / Farben auf Anfrage



Für perfekte Dach- und Trogpflanzung



RICOTER
Schweizer Erde

1.33 Erden

Erden in Säcken 	Liter/Sack	Säcke/Palette	palettweise CHF/Sack	einzel CHF/Sack
RICOTER 				
Aussaaterde Bio-Line	10	90	4.80	5.75
Aussaaterde, Substrat 220	70	39	15.53	17.44
Balkon- und Hochbeeterde Bio-Line	30	48	10.94	11.60
Blumen- und Geranienerde	15	60	7.54	8.68
	40	51	14.80	16.47
Gemüseerde Bio-Line	40	51	14.27	16.08
Bodenverbesserer (Fumor) kompostierter Mist	40	51	15.40	18.42
Dachgartenerde 204, 75% mineralisch	40	36	17.87	19.39
Gartenhumus, torffrei	30	40	9.74	10.24
Gartenkompost Bio-Line, torffrei (red. Rabatt)	30	48	7.35	8.29
Kräutererde Bio-Line	40	51	13.54	15.11
Mineralsubstrat (Dachgartenerde extensiv), torffrei, 100% mineralisch	40	33	19.20	19.89
Moorbeeterde torffrei Bioline	50	48	15.40	17.06
Profigärtner-Erde ohne Torf	40	51	12.94	14.52
Rasenerde Profi mit Perlit	30	44	13.14	14.52
Rasenerde torffrei Bio-Line	30	44	13.27	15.50
Rasentragschicht	30	40	11.54	13.55
Rindenkompost	40	51	11.00	12.19
Rosenerde	40	51	13.67	15.11
Südpflanzenerde, torffrei	30	48	11.67	12.58
Torfersatz 611, torffrei	80	36	15.20	15.50
Trogerde, 45% mineralisch, torffrei	40	42	14.34	15.50
Wasserpflanzenerde, torffrei	10	60	5.94	6.73
Zimmerpflanzenerde, torffrei	10	90	4.80	6.73

Pflanzenperlit 2 – 6 mm (red. Rabatt)	100	24	24.94	27.66
---------------------------------------	-----	----	-------	-------

1.35 Dekor- und Abdeckmaterialien

Garten Holzwolle 850 g		48	9.67	10.24
Holzchnitzel 6-50mm, FSC (red. Rabatt)	50	39	10.18	11.60
Kakaoschalen	50	39	16.34	18.42
Lärchenrinde 25-40mm	50	39	16.74	19.00
Pinienrinde fein 10-25 mm (red. Rabatt)	50	39	16.76	19.98
Pinienrinde mittel 25-40 mm (red. Rabatt)	50	39	16.76	19.98
Pinienrinde grob 40-60 mm (red. Rabatt)	50	39	20.24	22.90
Rindenabdeckmaterial 0–40 mm, FSC (red. Rabatt)	60	39	9.06	10.24
Lava Vulkangestein 8 – 16 mm (red. Rabatt)	15	30	9.06	10.64
Schilf-Mulch, torffrei	50	45	11.66	12.19

1.36 Ricoter-Produkte im Big-Bag (Preise per m³!)

 Preise ab Lager inkl. Ew-Big-Bag	Inhalt	CHF/m³
Blähschiefer 4-16mm	1,5 m³	344.71
Blähton 8-16 mm (Rundkorn)	2,0 m³	284.71
Blumen- und Geranienerde	2,0 m³	204.71
Dachgartenerde 204, 75% mineralisch	1,5 m³	311.77
Extensivsubstrat, 90% mineralisch	2,0 m³	288.24
Fallschutzelbelag Ricoplay 5-40mm	2,5 m³	263.53
Gartenkompost	1,5 m³	154.12
Gartenhumus	1,2 m³	196.47
Holzchnitzel 6-50 mm	2,5 m³	160.00
Landerde, trocken steril, ohne Steine	1,0 m³	174.64
Mineralsubstrat 100% mineralisch	1,5 m³	348.23
Moorbeeterde BioLine, torffrei	2,5 m³	214.12
Rasenerde, torffrei	1,2 m³	263.53
Rasengittersubstrat	1,2 m³	232.94
Rasentragschicht	1,2 m³	256.47
Rindenabdeckmaterial 0-40 mm	2,5 m³	143.53
Trogerde mineralisch (TIM) 45% mineralisch	1,7 m³	237.65



1.37 Torf (Tagespreise)

Torf (Tagespreise)	Liter/Sack	Säcke/Palette	palettweise CHF/Sack	einzel CHF/Sack
Baltic (Weisstorf)	250	18	23.50	24.90



1.38 Blähton Ricoter

Blähton Ricoter	Liter/Sack	Säcke/Palette	palettweise CHF/Sack	einzel CHF/Sack
Blähton braun 8-16 mm (Drainage) (red. Rabatt)	50	30	18.65	20.50
Blähton rot 8-16 mm (Hydro) (red. Rabatt)	25	44	15.23	17.11



1.39 Dachbegrünung /Flachdach (Saatgut)

Dachbegrünung /Flachdach (Saatgut)	kg/Sack	Saat g/m²	CHF/Sack	
OH-Extensivkräuter Myko	Sedumreich, mit Keimhel-fern, Wuchshöhe 10-40cm	2,5	90	88.20
		10	90	302.00
OH-ch Basler Kräuterdach Myko (einheimisch)	Sedumreich, mit Keimhel-fern, Wuchshöhe 10-40cm	10		312.00
Flachdachmischung Extensiv (Schweizer)	niedrigwachsend, blütenreich	1	10	86.83
Sedumsprossen-Mischung	Schnelle Begrünung	1	20-40	43.90

Grami®-Organic Plus

Organischer Rasendünger, staubfrei und geruchsarm

Neu!

Grami-Organic Plus ist ein staubfreier und geruchsarmer organischer Rasendünger zur Stärkung des Rasens. Der kalibetonte Grami-Organic Plus fördert die Rasennarbenbildung und Widerstandskraft des Rasens. Der hohe Anteil an Kali verbessert die Stressresistenz in den heissen Sommermonaten und sorgt für eine gute Winterhärte. Durch das enge N-K Nährstoffverhältnis ist Grami-Organic Plus der ideale biologische Rasendünger für das ganze Jahr.



1.40 Rasensamen

1.40.1 Haus- und Sportrasen	Verwendung	kg/Sack	Saat g/m ²	CHF/Sack
schweizer				
Master Seed Casa	Haus- und Spielrasen Profi	10	25 g	116.00
Master Seed Supina	Schattenrasen Profi	10	25 g	184.21
Basic Seed Sport	Standard Sportrasenmischung	10	25 g	106.24
Master Seed 13 Stern Rasen	Hitzeverträglicher Sport-und Hausrasen	10	25 g	121.83

OHS

OH-Spezial	Allzweckrasen hochstehend	10	20-30 g	124.00
OH Schatten	Schattenrasen	10	30-40 g	133.00
OH-Sport	Sportrasen	10	20-40 g	124.00
OH-Super	Top Feinrasen mit Turbo-Wiesenrispe	10	20-30 g	133.00
OH-Sport-Arido	Hitzeverträglicher Sport-und Hausrasen	10	20-40 g	121.00
OH-Lento	Zierrasen langsam, niederwachsend	10	5-40 g	160.00

1.40.2 Nachsaatrasen	Verwendung	kg/Sack	Saat g/m ²	CHF/Sack
schweizer				
Master Seed Regeneration	Nachsaatrasen Profi	10	10-30 g	115.98
Master Seed Stress Regeneration	Nachsaat für gestresste Rasenflächen, keimt auch bei tiefen Temperaturen	10	10-30 g	131.58

OHS

OH Topsaat-Turbo	Nachsaat mit Keimbeschleuniger	10	10-30 g	123.00
------------------	--------------------------------	----	---------	---------------

1.40.3 Rasen für Sonderanwendungen	Verwendung	kg/Sack	Saat g/m ²	CHF/Sack
schweizer				
Master Seed Schotter	für Schotterrasen oder Rasengitter	10	25 g	112.09
Master Seed Robo Lawn	Rasensaatgut für Roboter-Rasen	10	25 g	141.33

OHS

OH Robo-Spezial	Spezialmischung für Roboter	10	20-30 g	161.00
-----------------	-----------------------------	----	---------	---------------

Wir haben über Mittag durchgehend geöffnet!



schweizer



Drei Profi-Bio-Dünger

- ✓ Für biologische Rasen und Gärten
- ✓ Unbedenklich für Menschen und Haustiere
- ✓ Gemäss FiBL-Betriebsmittelliste für den biologischen Landbau in der Schweiz zugelassen



Produktdetails und Anweisungsempfehlungen

ericschweizer.ch | info@ericschweizer.ch

alle Preise exkl. MwSt

1.41 Rollrasen

Rollrasen Marke Schweizer	CHF/ m ²					
	m ² / Palette	1 - 10 m ²	11- 40 m ²	41- 120 m ²	121- 200 m ²	201- 400 m ²
Haus- und Spielrasen	60	25.24	20.37	16.47	15.11	13.16
Schattenrasen, geeignet für Höhenlagen	50	26.22	21.93	17.6	16.9	15.50



Gültigkeit: Ganzjährig.
Lieferung: DI bis FR, ausgenommen Feiertage.
Bestellfrist: 2 Arbeitstage.
Rollenmasse: 0.4 m x 2.5 m
Frachtkosten: Fix CHF 75.-/ Palette
 Keine Abholung möglich.
Terminlieferung: bis 10.00 Uhr.
 Zusätzlich CHF 50.-/ Bestellung

Rollrasen Marke OH inkl. Lieferung!

Hausrasen 0,4 x 2,5 m auf Humus

CHF/ m ² -> Inkl. Lieferung									
5 - 9 m ²	10- 19 m ²	20- 34 m ²	35- 44 m ²	45- 59 m ²	60 - 79 m ²	80- 129 m ²	130- 159 m ²	160- 249 m ²	250- 329 m ²
29.00	23.00	20.40	18.10	17.20	15.80	15.30	14.50	13.50	12.90

Nur gültig: Fricktal, Basel und direkt angrenzende Orte.
Anlieferung Standard: Werktags 8.00 - 12.00 Uhr
Bestellfrist: 2 Arbeitstage.
Rollenmasse: 0.4 m x 2.5 m

Frachtkosten: inbegriffen!
Terminlieferung: bis 10.00 Uhr
 Zuschlag CHF 50.-/ Pauschal

1.40.4 Wildblumenmischungen

Verwendung	kg/Sack	Saat g/m ²	CHF/Sack
schweizer			
Flora Suisse Blumenwiese	Wuchshöhe bis 100 cm	0,5	22.37
	Schnitthöhe 8 - 10 cm	3	112.09
		10	268.03
Mondoflor Blumenrasen	Wuchshöhe bis 25 cm	0,5	22.37
	Schnitthöhe 4 - 6 cm	3	112.09
		10	346.00
Nara Naturrasen	Wuchshöhe bis 30 cm	0,5	43.86
	Schnitthöhe 5 - 7 cm	3	209.55
		10	*726.12
Flachdachmischung Extensiv	niedrig wachsend bis 20 cm	1	10 g 86.74
OHS			
OH-ch Miniflora Myko	Blumenrasen mit CH Wildblumen	2.5	20 g 125.00
		10	*496.00
OH-ch Swissflora Myko	Wildblumenwiese mit CH-Wildblumen	2.5	20 g 137.50
		10	*555.00

* auf Bestellung
 Kleinpackungen von 500 g - 2 kg führen wir auch an Lager (Shop)
 Andere Rasensorten sind auf Bestellung kurzfristig lieferbar.

GARDENA

Wir haben **95%** des Gardena-Bewässerungssortiments an Lager!

1.42 Rasendünger

Rasendünger 	Verwendung	kg/Sack	Verbrauch in g pro m ²	CHF/Sack
schweizer (auf Anfrage)				
Certoplant Classic NPK 9,5-7-10 (Wirkzeit 3-4 Mte)	Neu-Nachsaat, Regeneration, Unterhalt	25	70-100	112.19
Certo-Starter NPK 12-12-10	Röllrasen, Neu- und Nachsaat	25	30-40	96.58
Certo Marathon 6M	mit Langzeitwirkung ganze Saison	25	50-80	121.95
Certo-Master 3M NPK 23-5-16 (Wirkzeit 3 Mte)	erhöhte Langzeitwirkung	25	30-40	121.95
Certo-Ferro NPK 9-0-5 + 10 Fe	für vermoosten Rasen	25	40-70	92.68
Certo-Ultimo NPK 5-1-15	Sommer- und Herbstdünger	25	40-70	86.83
Vivisol Bodenaktivator Bio Minigran	rein organischer Bodenverbesserer	25		57.56
Vegano Royal Bio Rasendünger Vegan	geruchsneutral, schont Boden und Umwelt	20	75	82.93

OHS

Grami-Dur NPK 23-5-8-2	Langzeit Volldünger	25	30-70	121.00
Grami-Start NPK 18-10-15-2	Ansaat und Herbstdüngung	25	30-70	117.00
Grami-Rapid NPK 18-5-8-2	Schnellwirkend und Frühjahrsdünger	25	20-40	78.20
Agrosil Bodenbeleger (D)	Wurzelaktivator auch gegen Moos	25	100	166.00
Grami-Robo Rasendünger		25	40-70	108.00
Grami-Top (42 S/Pal)	Rasentopdressing ohne Torf	40 l		20.66
OH Oscorna Rasaflor Rasendünger	FIBL, organischer Langzeitdünger	25	50-100	88.40
OH Grami Organic Plus Rasendünger	hochwertiger, organischer Langzeitdünger	20		71.00

Hauert

Ha-Ras Rasendünger		5	40-50 g	22.82
Rasen Expert Cornusol		25	100-150	122.17
Rasen Expert Duro		25	25-40	89.27
Rasen Expert Frühjahr		25	25-40	77.61
Rasen Expert Herbst		25	35-55	82.87
Rasen Expert Saat		25	25-40	84.27
Rasen Expert Standard		25	20-35	103.35
Rasentardit		15	80-100	76.00

1.43 Düngemittel

OHS 	Verwendung	kg/Sack	Verbrauch pro m ²	CHF/Sack
OH Compo Expert Kali Gazon	Kali-Magnesium Spezialdünger	25	30-50 g	98.00
Grami-Biochar Active (45 S/Pal)	hochwertige Pflanzenkohle, Bodenverbesserer	40 l		34.00

OHS

1.44 Düngemittel

Hauert-Biorga-Geistlich 	Bedarf g/m ²	Inhalt	Säcke pro Palette	einzel CHF/Sack
---	-------------------------	--------	-------------------	-----------------

Hauert

Arbostar Vollünger für Koniferen, Gehölz und Moorbeet	50-60	5 kg 25 kg	120 32	18.51 64.32
Beeren- u. Obstdünger	70-100	5 kg 20 kg	45 40	22.80 65.39
Blüte, Flüssigdünger		1 l	12	10.42
Gartenkalk mit Meeresalgen	50-100	8 kg	100	20.46
Gartensegen	60-120	5 kg 20 kg	45 40	22.80 65.39
Hornmehl (gedämpft)		2,5 kg	20x10	14.52
Hornspäne	30-40	1 kg 2,5 kg 5 kg 25 kg	36x12 30x8 120 24	7.50 15.78 26.80 78.46
Hühnermist gewürfelt		10 kg	60	17.46
Kali-Magnesia (Patent Kali)	20-50	5 kg	120	22.80
Kompostierter Mist		30 l	44	17.73
Kuhmist gewürfelt	150-200	10 kg	60	21.12
Laub-Nadelholzdünger	80-100	5 kg 20 kg	45 40	22.80 65.39
Lawnsand Moosverdränger	100	25 kg	40	43.07
Osmocote Exact Hi-End 3-4 Mt	40-80	25 kg	50	233.91
Osmocote Exact Hi-End 5-6 Mt	40-80	25 kg	50	243.66
Osmocote 5 Hi-End 8-9 Mt	40-80	25 kg		256.48
Rhodo Dünger	80-100	5 kg 20 kg	120 40	22.80 65.39
Rosendünger	80-100	5 kg 20 kg	120 40	22.80 65.39
Tardit Mega, 5-6 Mt	40-80	25 kg	50	178.36
Tardit Rose	80-100	2,5 kg	36	25.05
Tardit Top (Wirkung 2-3 Mt)		25 kg		114.03
Terravital Abdeckmulch	10l/m ²	150 l	15	26.80
Urgesteinsmehl	80-120	8 kg	100	18.22



1.45 Greenleaf Baumzubehör

1.45.1 RootRain Wurzelbewässerung

Bestehend aus: Bewässerungsrohr, T-Stück, Einlassstück mit Gitterverschluss aus HDPE. Beständig gegen Vandalismus durch nicht abnehmbares Einlassstück, Einlassöffnung Ø 80 mm

	Rohr -Ø	Rohrlänge	CHF/Stk.
RootRain Urban	60 mm	5 m	50.60
	60 mm	8 m	56.00
	80 mm	5 m	78.50
	80 mm	8 m	97.50
RootRain Civic	wie RootRain Urban mit hochwertiger Kappe aus pulverbeschichtetem Aluminium & Sicherheitskette (nur bei 60 mm)		Aufpreis zu Urban: 36.00/Stk.



Die Idee für Ihre Gartengestaltung
Gartenkiesfixierung SYTEC G-Fix®

Das kaum sichtbare, graue Kunststoffgitter fixiert Splitt oder Rundkies, reduziert Unkraut und verhindert das Einsinken von Gartenmöbeln.



www.sytec.ch

1.45.2

ArborVent Wurzelbelüftungsaufsatz

befahrbarer Aufsatz aus Aluguss mit einem drehbaren Lüftungsdeckel aus Edelstahl

	Grösse Einlassöffnung	passend auf Ø Rohr	CHF/Stk.
Aluminium	100x100 mm	100 mm	109.00



1.45.3

ArborAnker Wurzelballenverankerung für Bäume Unterirdisches Wurzelballenverankerungssystem

Modell	Bestehend aus	Baumumfang	Baumhöhe	CHF/Stk.
SASSP	3 Erdankern aus Komposit-Material Draht mit Ösen, Spanngurt	bis 20 cm	bis 4 m	52.00
SASMP	3 Erdankern aus Komposit-Material & je 1 m Halteseil 4 mm und Oese, Spanngurt 35mmx3,5 m	bis 35 cm	bis 6 m	62.50
SASLA	3 Erdankern aus Aluguss mit je 1 m Halteseil 6,4mm und Oese, Spanngurt 35mmx3,5m	bis 75 cm	bis 7,5 m	105.00
SASMD	3 Stahl-Schäkeln zur Befestigung an Stahlmatte mit Draht 3mm & Ösen, Spanngurt 25mm breit	bis 40 cm	bis 5 m	52.00
SASLD	3 Stahl-Schäkeln zur Befestigung an Stahlmatte mit Draht 6,4 mm & Ösen, Spanngurt 35 mm breit	bis 75 cm	bis 7,5 m	99.50



Zubehör

Modell	Bestehend aus	CHF/Stk.
SASTMX	Treibstange, für Arboranker SASMP	97.50
SASTLX	Treibstange, für Arboranker SASLA, SASLP	138.00
SAS-MAG	Ausziehgriffe für SASTM + SASTMX	233.00
SAS-LAG	Ausziehgriffe für SASTL + SASTLX	227.00
SASTLV	Lastverriegler für Anker	42.80



1.46 Baumbewässerung

Langzeit Tropfsystem

UV- und wetterbeständig, verbinden mehrerer Säcke mittels Reissverschluss möglich, mit Ösen für Schloss

Material	Inhalt	1 Stk. CHF/Stk.	ab 30 Stk. CHF/Stk.
Sack PE	75 l	21.50	19.90
	100 l	24.00	22.30
Sack PVC	75 l	17.50	15.50
Giessring PVC neu	55 l	18.00	16.00



1.47 Steinkörbe Sytec (nur auf Bestellung!)

1.47.1 Systemgabion Drahtstärke 4.5 mm, Maschenweite 10 x 10 cm * Punktgeschweisste Matten aus aluverzinktem Stahl.

inkl. Distanzhalter und Verbindungsmaterial (Spiralen oder Klammern)

Abmessungen (L x B x H) cm	Komplettkorb CHF/Stk.	Basispaket CHF/Stk.	Seiten-Set CHF/Stk.	Deckel-Set CHF/Stk.
Ohne Trennwand				
200 x 100 x 100	183.00	103.00	21.00	38.00
200 x 100 x 50	140.00	74.00	14.00	38.00
200 x 50 x 100	142.00	89.00	14.00	25.00
200 x 50 x 50	106.00	61.00	10.00	25.00
100 x 100 x 100	121.00	57.00	21.00	22.00
100 x 100 x 50	92.00	42.00	14.00	22.00
100 x 50 x 100	94.00	51.00	14.00	15.00
100 x 50 x 50	71.00	36.00	10.00	15.00
50 x 50 x 100	70.00	31.00	14.00	11.00
50 x 50 x 50	54.00	23.00	10.00	11.00
Mit Trennwand				
200 x 100 x 100	207.00	125.00	21.00	40.00
200 x 100 x 50	156.00	88.00	14.00	40.00
200 x 50 x 100	160.00	106.00	14.00	26.00
200 x 50 x 50	119.00	73.00	10.00	26.00
100 x 100 x 100	121.00	57.00	21.00	22.00
100 x 100 x 50	92.00	42.00	14.00	22.00
100 x 50 x 100	94.00	51.00	14.00	15.00
100 x 50 x 50	71.00	36.00	10.00	15.00
50 x 50 x 100	70.00	31.00	14.00	11.00
50 x 50 x 50	54.00	23.00	10.00	11.00



1.47.2 Systemgabion Drahtstärke 4.5 mm, Maschenweite 5 x 10 cm * Punktgeschweisste Matten aus aluverzinktem Stahl.

inkl. Distanzhalter und Verbindungsmaterial (Spiralen oder Klammern)

Abmessungen (L x B x H) cm	Komplettkorb CHF/Stk.	Basispaket CHF/Stk.	Seiten-Set CHF/Stk.	Deckel-Set CHF/Stk.
Mit Trennwand alle 1m				
200 x 100 x 100	256.00	150.00	27.00	52.00
200 x 100 x 50	188.00	102.00	17.00	52.00
200 x 50 x 100	198.00	131.00	17.00	33.00
200 x 50 x 50	143.00	86.00	12.00	33.00
200 x 25 x 100	168.00	120.00	13.00	22.00
200 x 25 x 50	121.00	79.00	10.00	22.00
100 x 100 x 100	152.00	70.00	27.00	28.00
100 x 100 x 50	111.00	49.00	17.00	28.00
100 x 50 x 100	116.00	63.00	17.00	19.00
100 x 50 x 50	85.00	42.00	12.00	19.00
100 x 25 x 100	99.00	59.00	13.00	14.00
100 x 25 x 50	76.00	42.00	10.00	14.00
50 x 50 x 100	85.00	38.00	17.00	13.00
50 x 50 x 50	64.00	27.00	12.00	13.00
50 x 25 x 100	74.00	37.00	13.00	11.00
50 x 25 x 50	59.00	28.00	10.00	11.00

1.47.3 Systemgabion Drahtstärke 4.5 mm, Maschenweite 5 x 2,5 cm * Punktgeschweisste Matten aus aluverzinktem Stahl.

inkl. Distanzhalter und Verbindungsmaterial (Spiralen oder Klammern)

Abmessungen (L x B x H) cm	Komplettkorb CHF/Stk.	Basispaket CHF/Stk.	Seiten-Set CHF/Stk.	Deckel-Set CHF/Stk.
Mit Trennwand alle 1m				
200 x 100 x 100	406.00	227.00	44.00	91.00
200 x 100 x 50	279.00	136.00	26.00	91.00
200 x 50 x 100	315.00	208.00	28.00	51.00
200 x 50 x 50	204.00	121.00	16.00	51.00
200 x 25 x 100	272.00	198.00	20.00	34.00
200 x 25 x 50	172.00	114.00	12.00	34.00
100 x 100 x 100	238.00	104.00	44.00	46.00
100 x 100 x 50	165.00	67.00	26.00	46.00
100 x 50 x 100	182.00	98.00	28.00	28.00
100 x 50 x 50	121.00	61.00	16.00	28.00
100 x 25 x 100	154.00	94.00	20.00	20.00
100 x 25 x 50	104.00	60.00	12.00	20.00
50 x 50 x 100	134.00	60.00	28.00	18.00
50 x 50 x 50	86.00	36.00	16.00	18.00
50 x 25 x 100	115.00	62.00	20.00	13.00
50 x 25 x 50	75.00	38.00	12.00	13.00

➔ * Nur auf Bestellung! Bis 4 Tage Lieferfrist

Hinweis für Bezüge von Steinkörben Sytec:

- bis zu einem Warenwert von Brutto CHF 500.- Transportpauschale CHF 100.- pro Lieferung
- ab Brutto CHF 501.- Transportpauschale CHF 175.- pro Lieferung
- ab Brutto CHF 2000.- franko

1.48 arcadia® Pergone® 16 cm

16 cm MW 25/200 - Säule zum Einbetonieren

	Höhe	Einzelpreis CHF
Grundelement Elementlänge: 254 cm (2 Säulen, 2 Gittermatten, Klemmen, Abstandhalter)	63	311.01
	83	377.93
	103	427.25
	123	483.14
	143	554.44
	163	601.29
Erweiterungselement Elementlänge: 254 cm (1 Säule, 2 Gittermatten, Klemmen, Abstandhalter)	63	229.05
	83	287.97
	103	329.90
	123	374.72
	143	436.21
	163	474.51
	183	517.31
	203	589.64

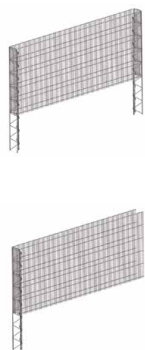

1.49 arcadia® PERGONE® 23 cm (ab Lager erhältlich)

Elementmasse: Länge ca. 250cm, Tiefe: ca. 23 cm
Alle Preise ohne Steinfüllung, unmontiert, MW 50/200 mm

Höhe	Grundelement		Erweiterungselement	
	Artikel-Nr.	Einzelpreis CHF	Artikel-Nr.	Einzelpreis CHF
63 cm	A78H31	312.13	A78H32	222.57
83 cm	A78H41	371.00	A78H42	271.62
103 cm	A78H51	421.08	A78H52	307.43
123 cm	A78H61	469.55	A78H62	344.45
143 cm	A78H71	531.53	A78H72	396.34
163 cm	A78H81	578.49	A78H82	432.09
183 cm	A78H91	623.28	A78H92	466.31
203 cm	A78H101	717.30	A78H102	533.73
223 cm	A78H111	774.28	A78H112	577.29
243 cm	A78H121	847.85	A78H122	629.81

➔ Weitere Arcadia-Produkte gemäss separater Preisliste!
Download unter www.spaeth.ch

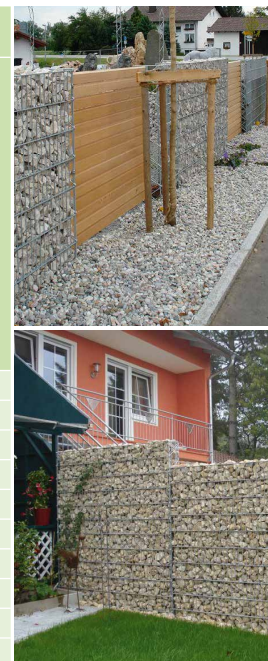

1.50 arcadia® Hochbeet

kompletter Bausatz aus Drahtgittern, ohne Füllung

	Breite	Höhe	Einzelpreis CHF	
Maschenweite 50x200mm Länge: 250cm	120	60	363.85	
	120	80	443.94	
Maschenweite 25x200mm Länge: 120cm	120	60	338.16	
	120	80	411.69	
	Länge: 250cm	120	60	468.61
		120	80	577.43

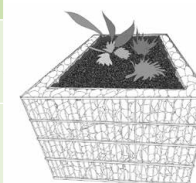

fortec[®]



www.fortec.swiss

FÜR INDUSTRIE UND GEWERBE

alle Preise exkl. MwSt

1.51 Containernischen

Kehricht-Containernischen Arcadia Bausätze zum einbetonieren

	Breite x Tiefe	Höhe	Einzelpreis CHF
U-förmig Pergonen zum füllen mit Schotter	320 x 109 cm	140	1190.00
C-förmig Pergonen zum füllen mit Schotter	320 x 177 cm	140	2350.00



1.52 Faltzelle Profi

Stabile Faltpavillons für verschiedenste Anwendungen zum attraktiven Preis. In nur 2 Minuten aufgebaut.

FALTPAVILLONS mit Alugestänge

Dach 300 g/m², nicht feuerhemmend, Beine 6-Kt., inkl. Tasche
Farben: weiss, hellgrün, dunkelgrün, blau, rot,gelb,orange,schwarz

Zeltgröße		Einzelpreis CHF
3 x 3 m	Gestell inkl. Dach, 22,2 kg	668.00
4,5 x 3 m	Gestell inkl. Dach	933.00
6 x 3 m	Gestell inkl. Dach	1300.00
4 x 4 m	nur weiss, Gestell inkl. Dach	1085.00

Individuelle Bedruckung möglich. Bitte anfragen.



1.53 Graf Regenwassernutzungsanlagen

Die komfortable Komplettlösung für die Gartenbewässerung **neu**

- Hoher Bedienungskomfort – Pumpe schaltet automatisch ein und aus
- Integrierte Filtertechnik (100 % Wasserausbeute)
- Einfache Installation und bequeme Wasserentnahme
- inkl. Automatik-Tauchpumpe und sämtlichem Zubehör

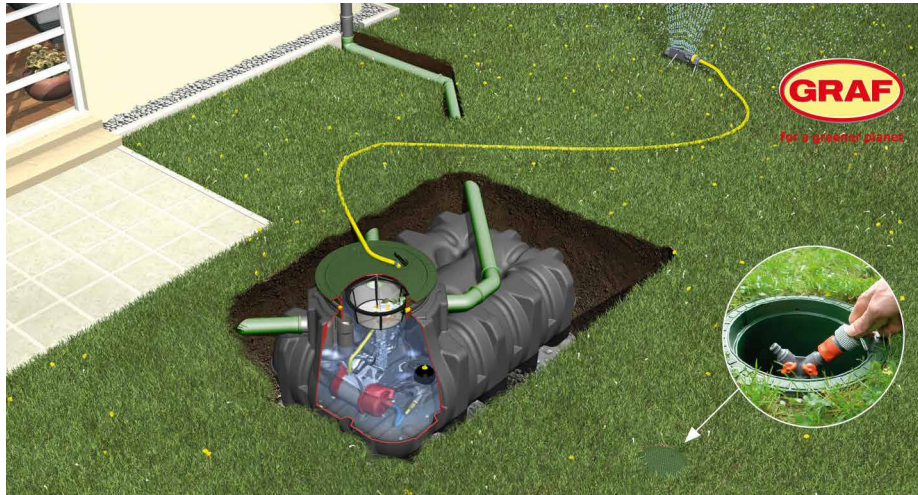

Platin Komplettpaket Garten-Komfort

Inhalt	Anschluss (DN)	begehrbar Art. Nr.	befahrbar Art. Nr.
1500 l	100	390105	390205
3000 l	100	390106	390206
5000 l	100	390107	390207
7500 l	100	390108	390208



Carat/Carat XL Komplettpaket Garten-Komfort

Inhalt	Anschluss (DN)	begehrbar Art. Nr.	befahrbar Art. Nr.
2700 l	100	370110	370210
3750 l	100	370111	370211
4800 l	100	370112	370212
6500 l	150	370113	370213
8500 l	150	370152	370252
10000 l	100	370153	370253



Preise bitte Anfragen

Baumaterialien



BAUMATERIAL SPÄTH
Bau- und Gartenbedarf

Sackstarke Produkte



2.1

Bindemittel	Gebinde kg	Menge/ Palette	ab 1 Palette CHF	einzel CHF
Zement CEM II, A-L 32,5	25	56	7.80	8.50
Trass Zement Tubag TZ-0	25	54	12.50	13.50
Weisszement superblanc CEM 52,5	25	48	15.50	17.00
PCI Novoment Z1	25	42		89.00
Schnellbindemittel 1-Tag Abbindezeit				
PCI Novoment Z3	20	48		43.40
Schnellbindemittel 3-Tage Abbindezeit				

2.2

Beton, Überzüge (Estriche)	Gebinde kg	Säcke/ Palette	palettweise CHF/Sack	einzel CHF/Sack
Estrichbeton, 0-8mm «no Name» B25	30	42	7.60	8.50
weberton 908, Trockenbeton 0-8 mm +	25	40	9.60	10.60
weberton 916, Trockenbeton 0-20 mm +	25	40	9.30	10.60
weberton 904, Überzugsmörtel, 0-4 mm, PC 400 +	25	40	9.80	10.80
weberton 916 XF4, Frost-Tausalz-beständiger Beton, Korn 0-20 mm + neu	25	40	10.20	11.20
PCI Pavifix FFM Füll- und Montagemörtel ohne mischen, schnellabbindend	25	40		18.30
weberton no mix Beton +	25	40	14.50	15.50
Sakret Setz-Fix Turbo	25	42	12.80	14.50
Sakret Subito 16 Schnellbeton 0-20 mm	25	42	13.35	14.35
SwissMix EcoCrete 16 Recycling-Beton neu	25	42	10.20	11.10
SwissMix LightCrete 16 (ersetzt LiaporMix) neu	20	30	36.00	38.50
PCI Novoment flow Fliessestrich-Fertigmörtel selbstlaufend (20-80mm)	25	42		42.00
PCI Novoment light (20-80mm)	15	48		43.35
PCI Novoment M1 plus, Schnellüberzug, nach 1 Tag belegbar (20-80 mm)	25	42		46.75
PCI Novoment M3 plus, Schnellüberzug nach 3 Tagen belegbar (20-80 mm)	25	42		22.00
PCI Zemtac 180, direkt nutzbarer Fliessestrich für innen & aussen (15 - 80 mm)	25	42		51.50
Mapei TOPCEM Pronto normalabbind. Mörtel	25	40		16.75
Mapei Mapedrain Monokorn	25	40		29.00
Sikacrete®-08 SCC (selbstverdichtend)	25	42	15.80	17.00



2.3

Putze	Gebinde kg	Säcke/ Palette	ab 1 Pal. CHF	einzel CHF
weber ip 12, Zementanwurf	30	36	17.80	19.00
weber ip 14, Zement-Sockelputz	25	36	14.60	15.80
weber ip 18, Zement-Kalk-Putz	25	36	13.20	14.40
weber ip 18 turbo	25	36	14.50	16.10
weber ip 18E, Zement-Kalkleichtputz	30	36	19.80	21.00
weber multi 280, Kunststoffvergüteter, Kleber und Spachtel, grau	25	42	44.00	46.20
weber multi 290 E, hell	25	42	53.00	56.00
weber 172 / IP 370	30	42	26.50	28.00
weber reno-uni, schnellabbindender Renovationsputz	20	48	43.00	44.60
PCI Pericret, Ausgleichsputz schnellabbindend, 3-50 mm	25	42		63.00
Mapei Nivoplan Spachtelmasse, 2-20 mm	25	40		21.00
Mapei Planitop Fast 330, Reparaturmörtel, 3-30 mm	25	40		54.50
Mapei Planitop 400, Reparaturmörtel für 1-40 mm	25	40		45.00
PCI Saniment 2in1, Sanierputzmörtel	25	42		80.00

2.4

Mauermörtel	Gebinde kg	Säcke/ Palette	ab 1 Palette CHF	einzel CHF
weber mur 920, Zementmauermörtel	25	40	8.85	9.90
weber.mix 614, Trass-Kalkmörtel,	25	42	13.00	14.20
weber.mix 615, Trass-Zementmörtel,	25	42	13.50	14.80
weber mur 980, Sichtmauermörtel	25	40	11.00	12.30
weber.dur 141 (810) Schlitz-/Verfüllmörtel	20	35	17.80	19.00
Ytong-Dünnbettmörtel	15			38.00
Sakret Cheminéeemörtel	30	36	32.00	33.65



2.5

Reparaturmörtel	Gebinde kg	Säcke/Palette	CHF/Gebinde
PCI Repafix, Schnellreparaturmörtel (2-50 mm)	5		29.25
	25	42	109.00

2.6

Reparaturmörtel speziell für Böden	Gebinde kg	Stk./Palette	CHF/Gebinde
Mapei Eporip Turbo 2k zum Schliessen von Rissen	0,5		16.32
Mapei MapeSlop Instandsetzungsmörtel, bis 5 cm neu	25	50	46.00
Mapei Planitop fix, schnellabbindender Reparaturmörtel	25	40	43.75
PCI Apogel F, Injektions- und Giessharz (2K)	1		75.72
PCI Apogel schnell, Injektions- und Giessharz (2K)	0,5		62.10

	Gebinde kg	Stk/Palette	CHF/Gebinde
PCI Apogel SH, Silikat-Giessharz	0,6 l		33.15
PCI Aposan, Schwerlast-Reparaturmörtel	5	60	154.50
PCI Bauharz, Epoxi-Bindemittel	10	28	332.30
PCI Repafast Fibre, faserarmerter Reparaturmörtel, 10-150 mm, für Verkehrsflächen bis -10°C	25	48	100.25
PCI Repafast Fluid, giessfähiger Reparaturmörtel 10-100 mm, für Verkehrsflächen bis -10°C	25	48	81.75
PCI Repafast Tixo, standfester Reparaturmörtel 10-100 mm, für Verkehrsflächen bis -10°C	25	48	84.00
PCI Repahaft, Haftschlämme für Überzüge & Reparaturen	5	40	31.80
	25		115.25
PCI Repament Multi variabler Schnellmörtel innen & aussen, 10-70 mm	25	42	30.75

2.7

Montagemörtel, Vergussmörtel	Gebinde kg	Stk/Palette	CHF/Gebinde
Mapei Mapefill Zero, Vergussmörtel	25	40	30.00
PCI Polyfix-30-Sekunden, Blitzmontagemörtel, Eimer	1		9.12
PCI Polyfix-5-Minuten, Schnellmontagemörtel, Eimer	1		10.05
	5	75	24.90
	15	24	51.60
PCI Polyfix Plus L, wasserdichter Schnellmontagemörtel für den Tiefbau, normal oder langsam abbindend	Eimer 20	24	43.40
	Sack 25	42	48.25
PCI Polyfix WP Schnellmörtel, wasserdicht, zum Stoppen von Wassereintrüben	15		72.15
PCI Repaflow Vergussmörtel für 5-100 mm	25	42	47.00
PCI Repaflow Plus Vergussmörtel für 40-150 mm	25	42	48.75
PCI Repaflow Turbo, nach 60 Min. befahrbar	20	50	66.40
PCI Repaflow Uni, Verguss- und Ankermörtel, schwindkompensiert, 20 - 80 mm	25	42	23.75

2.8

Nivelliermassen	kg	Stk/Palette	CHF/Sack
Mapei Ultraplan Eco Xtra, Nivelliermasse (1 - 10 mm)	25	40	41.00
Mapei Ultraplan Maxi, Nivelliermasse (3 - 30 mm)	25	40	47.75
PCI Periplan Extra, Nivelliermasse faserarmiert (3 - 60 mm)	25	42	94.00
PCI Periplan Flow, Nivelliermasse (0,5 - 50 mm) neu	25	42	56.75
PCI Periplan Multi, Nivelliermasse faserarmiert (3 - 40 mm)	25	42	68.00
PCI Zemtec 1K, (3 - 30 mm) direkt nutzbar	25	42	99.00
Armiermatten zum Einbau in Nivelliermasse		CHF/m² offen	CHF/m² ganze Rollen
PCI GFM, 0.9 m breit, Rollenlänge 100 m		14.50	13.30
PCI GFS, 0.8 m breit, Rollenlänge 45 m		21.30	19.56



NATUR- STEIN



SICHER VERLEGEN UND VERFUGEN
PCI CARRA-FAMILIE UND PCI PAVIFIX-FAMILIE



Umfassendes Produktsortiment mit Naturstein- und Galabauspezialitäten.

- Zum Verlegen und Verfugen von Naturstein
- Natursteinbeläge und -mauern dauerhaft schön und funktional
- Hochwertiger GaLaBau und Naturstein gehören zusammen

2.9

Betoninstandsetzung	Gebinde	Stk./Palette	CHF/Gebinde
PCI Barrafil L, Kosmetikmörtel (1 - 7 mm), hellgrau	8 kg	65	42.72
Hellgrau oder dunkelgrau (im Eimer)	20 kg	24	96.20
PCI Nanocret AP Korrosionsschutz im Eimer	4 kg	75	48.88
	15 kg	24	150.75
PCI Nanocret R2 Reparaturmörtel (3 - 100mm)	20 kg	48	65.40
PCI Nanocret R3 Reparaturleichtmörtel (3 - 50 mm)	25 kg	42	82.75
PCI Nanocret R4 fluid (2 - 200 mm)	25 kg	48	72.75
PCI Nanocret R4 PCC hochfester Instandsetzungsmörtel (5 - 50 mm)	25 kg	42	61.75
PCI Nanocret R4 Rapid (5 - 50 mm)	25 kg	42	60.00
PCI Nanocret R4SA (5 - 40 mm)	25 kg	48	48.00
PCI Nanocret FC Flächenspachtel, (1 - 10mm)	25 kg	42	105.25
PCI Polycret 50 Ausgleichsmörtel neu	25 kg	42	48.25
PCI Polycret Multi Reparaturmörtel neu	25 kg		55.00







2.10

Zusätze für Mörtel/Beton	Gebinde	Stk./Palette	CHF/Gebinde
Mapei Mapeform Allround Schalttrennmittel auch für Asphalt	20 l		139.60
PCI Barra Emulsion für Flickmörtel, Putze	10 kg	60	85.50
	25 kg	24	206.25
PCI CK 310 Beton-Trennmittel (Schalöl), für alle Schalungen geeignet	5 l		55.35
	10 l		93.10
	20 l		126.60
	Fass 215 l		1231.95
Sika 4a, Dichtungsmittel schnellbindend	5 kg		9.60/kg
	15 kg		9.25/kg

2.11

Diverse Klebemörtel	Gebinde	Stk./Karton	CHF/Gebinde
Mapei Adesilex PG4, 2-komp. Reaktionsharzkleber	6 kg		128.46
	30 kg		592.20
Mapei Mapeflex MS45 grau, Hybridkleber & Dichtstoff	300 ml	12	9.51
Mapei Mapeflex MS45 weiss, Hybridkleber & Dichtstoff	300 ml	12	9.69
Mapei Ultrabond MS rapid weiss, Montagekleber Hybrid	300 ml	12	15.46
Mapei Ultrabond ECO PU 2k grau	10 kg		154.80
Mapei Mapeflex PU45 FT grau, Polyurethan Dicht- & Klebstoff	300 ml	12	15.26
Mapei Mapefix VE SF, Verankerungskleber 2-K	300 ml	12	24.34
PCI Barrafix EP, 2-K-Epoxi-Baukleber	25 kg		354.25
	6 kg		
PCI Barrafix 920, universeller Verankerungskleber (Kart.)	300 ml	12	151.62
PCI Stabiflex, Kiesbettverfestiger für Flachdächer	20 l		391.60
PCI Uniform grau oder weiss, Hybridkleber & Dichtstoff	480 g	12	9.79
Sikadur 31 Kleber Normal od. Rapid	1,2 kg		35.00/Stk
	6 kg		142.80

2.12

Gipse/Weissputz/Gipskleber	Gebinde kg	Menge/Palette	ab 1 Palette CHF/Gebinde	einzel CHF/Gebinde
Ansetzbinder Perlfix	30	40	17.80	19.80
Baugips 15  (Granol)	30	21	21.50	22.80
Gipsplattenkleber/Spachtel Alba AGK plus 	25	30	39.50	49.30
Gipsplattenkleber/Spachtel Hydro AGKH plus 	25	30	57.30	71.70
Granol 200 Weissputz 	30	21	28.00	30.50
Granol 220 Weissputz 	30	21	29.00	31.00
Weber Reno-GSP Gipsleichthaftputz	25	36	36.00	38.00
Granolan Kombihaftbrücke 	20	24	108.50	116.00
Knauf MP 75 Gips-Maschinenputz L	30	40	14.50	15.60
Knauf SM 700 Pro weiss 1,0 mm Klebemörtel	25	42	34.50	36.00
Knauf Uniflott	5			19.00
	25	42		69.00
Knauf Uniflott (imprägniert) grün	5			23.00
Rifino Top, Gipsfeinspachtel	25	40	57.00	61.00

2.13

Abdichtungsprodukte, Rohbau, Perimeterkleber	Gebinde	Menge/Pal.	CHF/Gebinde
Mapei Plastimul 2K Plus Perimeterkleber/Dickbeschichtung	30 kg	18	114.90
PCI Barrapren (Bitumen-Dickbeschichtung, 1K)	30 kg	14	113.10
PCI Barraseal Dichtschlämme	25 kg	42	66.25
PCI Barraseal Ready 1K Abdichtung neu	8 kg	18	155.00
PCI Barraseal Ready 1K Vlies, 0.3 x 20 m neu	20 kg	96	163.20
PCI Barraseal Turbo 2K Reaktivabdichtung	20 kg	18	155.00
PCI Pecimor F, Bitumen-Schutzanstrich	5 l		35.30
	10 l		57.10
	33 l	18	159.06
PCI Pecimor 2K (Perimeterkleber)	30 l	18	136.50
PCI Pecimor DK (Foamglaskleber)	28 kg	18	157.92
Mapei Mapeband 150-1 mm	20 m/R.		181.00
Flex Roll 150-2 mm	20 m/R.		296.40
	200-1 mm	20 m/R.	216.80
	200-2 mm	20 m/R.	364.60
	300-1 mm	20 m/R.	335.00
	300-2 mm	20 m/R.	532.80
PCI Pecitape 3000 Abdichtungsband 1 mm stark, 15 cm breit	20 m/R.		160.60
	20 m/R.		175.80
	20 m/R.		285.80
	20 m/R.		533.20
	20 m/R.		303.20
PCI BT 23 Dichtband selbstklebend (bis -5°C) 15cm x 25m			210.50
	30cm x 25m		412.75
Sika Multiseal, bituminöses, selbstklebendes Dichtungsband	10cm x 10m		50.80
	15cm x 10m		72.90
	20cm x 10m		106.00
Vandex-Betonbauschlämme BB 75	25 kg	50	49.00

2.14

Abdichtungsprodukte für Fliesenleger	Gebinde	Menge/Pal.	CHF/Stk.
Mapei Mapegum WPS, 1-K-Dispensions-Abdichtung	10 kg	54	94.80
	20 kg	30	176.40
Mapei Mapelastic dunkel, 2-Komp.-Dichtschlämme Kp. A	24 kg	40	25.92
	8 kg	66	152.80
Mapei Monolastic Ultra grau, 1-Komp.-Dichtschlämme	20 kg	50	208.40
Mapelastic Aqua Defense, Abdichtung	15	33	194.10
Mapeband Grey, Dichtband 12cmx50m	50 m		224.50
Mapeband Grey Innen oder Aussen			10.35
Mapeband Butyl SA	20 m		189.80
Mapei Mapeguard IC, Innenecken blau	25/P.		10.98
Mapei Mapeguard PC, Dichtmanschette 10x10cm, 15-38mm	25/P.		7.46
Mapei Mapeband Easy H130 Innen- oder Aussenecken	30 m		230.10
	10 Stk		13.36
Mapei Mapeband Shower Tray Innenecken H20 links o. rechts H28 links o. rechts			13.47
			13.47
PCI Lastogum, grau oder weiss	4 kg		57.84
	8 kg		106.96
	15 kg		174.30
PCI Pecitape 120 (Sicherheitsdichtband 120), 12 cm breit	50 m		491.50
PCI Pecitape WS, selbstklebendes Dichtband, 10 cm breit	20 m		200.00
PCI Pecitape 250 (Sicherheitsdichtband 250)	20 m		298.60
PCI Pecitape 10x10 (Dichtmanschette Wand)		10/Karton	8.27
PCI Pecitape (Dichtmanschette Boden) 42,5x42,5cm			60.53
PCI Pecitape 90° A (Dichtecke aussen)		10/Karton	12.42
PCI Pecitape 90° I (Dichtecke innen)		10/Karton	12.42
PCI Pecitape Protect Schnittschutzband	10 m		148.10
	20 m		282.40
PCI Seccoral 1-K-Abdichtung	15 kg	64	137.25
PCI Seccoral 2-K Rapid Set	25 kg	64	276.00

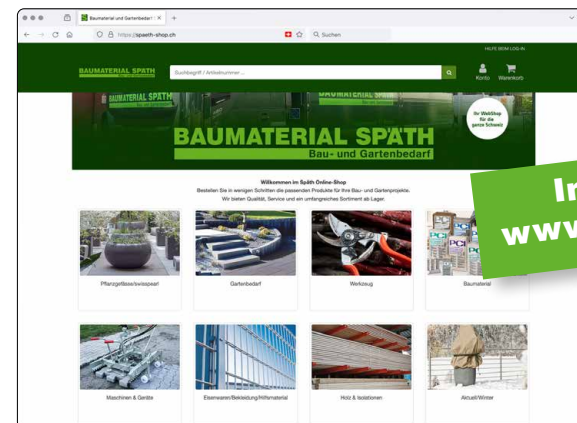

Immer aktuell:
www.spaeth-shop.ch

2.15

Pflege und Reinigung von Keramik-/Naturstein-Bodenplatten	Gebinde	CHF/Geb.
Lithofin Anti Rutsch Behandlungs-Set	1 l	64.60
Lithofin KF Fugenreiniger	0,5 l	18.65
Lithofin KF Pflegereiniger, für Feinsteinzeug und Keramik	1 l	18.40
Lithofin Cotto Extraschutz «W»	1 l	53.90
Lithofin-Alex Konzentrat, Algen- und Moosentferner	1 l	31.45
	5 l	134.95
Lithofin-KF (FZ) Intensivreiniger	1 l	21.25
Lithofin-KF Zementschleierentferner	1 l	21.25
Lithofin-ASR Spezialreiniger, Konzentrat (Profi)	1 l	32.65
Lithofin- KuKü Zementschleierentferner	1 l	18.75
Lithofin-Lösefix, für keramische Beläge	1 l	33.15
Lithofin Aktivreiniger f. Aussenflächen	2,5 l	45.00
Lithofin-MN Aussenreiniger, Algen, Grünbeläge, Pilze	1 l	22.15
	5 l	92.70
Lithofin-MN Fleckstop (Imprägnierung), gegen Wasser, Öl, Fett	1 l	64.15
Lithofin-W Fleckstop	1 l	49.00
	5 l	220.00
Lithofin-MN Grundreiniger, säure- und lösemittelfrei	1 l	22.90
Lithofin-MN Zementschleierentferner, für Natursteine	1 l	18.85
Lithofin MN Wash&Clean	1 l	22.80
Lithofin MN Farbvertiefer	1 l	39.60
Lithofin Resin-Ex Entferner für.Epoxy und Pflasterfugenmörtel	1 l	52.00
Lithofin Rost-EX	0,5 l	18.95
Mapei Mapestop, zur Hydrophobierung von Bettungsschichten von Natursteinen und Verbundsteinen	1 kg	206.34



2.16

Grundierungen	Gebinde	CHF/Geb.
Mapei Eco Prim Grip Plus, Universal-Grundierung	5 kg	76.85
	10 kg	134.00
Mapei Isolastic, elastifizierende Dispersion	10 kg	95.60
Mapei Latex Plus, elastifizierender Zusatz	10 kg	77.30
Mapei Primer G, Dispersionsgrundierung	10 kg (66/Pal.)	80.40
PCI Epoxigrund Rapid	1 kg	67.10
	5 kg	273.00
PCI Epoxigrund 390	1 kg	63.30
	10 kg	384.90
PCI Gisogrund	1 l	20.97
	5 l	80.35
	10 l	138.50
	20 l	253.60
	200 l	2076.00



Die professionelle Lösung

Spezialprodukte zum Reinigen, Schützen und Pflegen von Keramik, Feinsteinzeug, Naturstein, Cotto etc.



Lithofin AG Bödlern 2 5420 Ehrendingen Tel. 056 203 18 50 lithofin.ch

Grundierungen	Gebinde	CHF/Geb.
PCI Gisogrund Rapid	5 l	103.95
	10 l	181.80
PCI Gisogrund 303, auf glatte, nicht saugende Untergründe	1 l	43.44
	5 l	195.95
	20 l	646.00
PCI Gisogrund 404, auf saugende und nicht saugende Untergründe	1 l	44.70
	5 l	157.95
	20 l	544.60
PCI Wadian, Grundierung auf Spanplatten	5 l	207.25



2.17

Fliesenkleber (Plättlikleber)	Gebinde kg	Säcke/Palette	Gebinde/CHF
Cermix Cermiset CH grau	25	42	34.50
Mapei Adesilex P9 Plus, grau, flexibler Dünnbettkleber	25	40	30.25
Mapei Elastorapid KIT grau, 2-Komp.-Kleber	Komp. A	25	51.25
	Komp. B	6,25	96
Mapei Keraquick S1 Plus, grau, flexibler Schnellkleber	25	40	58.75
Mapei Keraflex Vario S1, grau, flexibler Dünnbettkleber	25	40	46.00
Mapei Keraflex Vario Quick S1	25	40	51.25
Mapei Keraflex S1, grau	25	40	43.00



Mapecoat® TNS

...VERWANDELT IHRE URBANEN OBERFLÄCHEN!



Zur Broschüre



mapeiswitzerland

Mehr Infos: www.mapei.ch

alle Preise exkl. MwSt

Fliesenkleber (Plättkleber)	Gebinde kg	Säcke/ Palette	Gebinde/ CHF
Mapei Ultralite S1, Flex Zero, Leichtklebemörtel	15	50	29.55
PCI Lastoflex, flexibilisierender Zusatz	4	90	90.16
PCI Collastic, Spezialkleber weiss auf Stahl	3	100	148.77
PCI Flexmörtel S2, Klebbettdicke 1 - 10 mm	20	48	59.20
PCI Flexmörtel S1 Flott	20	48	41.40
PCI Flexmörtel Nanorapid	20	48	50.20
PCI Flexmörtel Premium	20	48	63.40
PCI FT-Extra	25	42	37.75
PCI FT-Flex	18	48	41.76
PCI Nanolight	15	48	45.15
PCI Nanolight white	15	48	48.75



2.18

Fugenmörtel für Fliesen	Stk./ Palette	CHF/ Gebinde
Mapei Keracolor Plus 294, basalt		40.71
Mapei Keracolor Plus 112, mittelgrau		46.92
Mapei Keracolor Plus 113, zementgrau		40.02
Mapei Keracolor FF 100, weiss, 2-6 mm	40	58.25
Mapei Keracolor FF 103, mondweiss, 2-6 mm	40	53.75
Mapei Keracolor FF 111 silbergrau, 2-6 mm	40	54.00
Mapei Keracolor FF 112 mittelgrau, 2-6 mm	40	57.25
Mapei Keracolor GG Flex 111 silbergrau, 4-15 mm	40	44.25
Mapei Keracolor GG Flex 112 mittelgrau, 4-15 mm	40	51.00
Mapei Keracolor GG Flex 113 zementgrau, 4-15 mm	40	43.50
Mapei Keracolor GG Flex 114 anthrazit, 4-15 mm	40	44.75
Mapei Kerapoxy, 2-K-Epoxyklebstoff, div. Farben		42.84
Mapei Kerapoxy Easy design, 3 kg, div. Farben		61.14
Mapei Ultracolor Plus 111, Flexfuge 2-20 mm, 22 kg	40	96.58
Mapei Ultracolor Plus 112, Flexfuge 2-20 mm, 22 kg	40	84.04
Mapei Ultracolor Plus 113, Flexfuge 2-20 mm, 22 kg	40	70.40
Mapei Ultracolor Plus 114 anthrazit, Flexfuge 2-20 mm, 5 kg		19.30
Mapei Ultracolor Plus 120 schwarz, Flexfuge 2-20 mm, 5 kg		23.10
Mapei Ultracolor Plus 130 jasmin, 5 kg		24.55
Mapei Ultracolor Plus 132 beige, Flexfuge 2-20 mm, 5 kg		24.55
Mapei Ultracolor Plus 133 sand, 5 kg		30.05
Mapei Ultracolor Plus 134 seide, 5 kg		30.05
Mapei Ultracolor Plus 135 gold pulver, 5 kg		30.05
Mapei Kerapoxy easy design, 3 kg, div. Farben neu		61.14
PCI Durapox Premium, div. Farben	2	49.74
	5	113.25
PCI Nanofug Premium, diverse Farben	5	30.35
	15	83.10

www.spaeth-shop.ch

BAUMATERIAL SPÄTH
Bau- und Gartenbedarf



SAKRET AG/SA
 Gewerbestrasse 1
 CH-4500 Solothurn
 Tel. 032 624 55 40
 info@sakret.ch
 www.sakret.ch



2.19

Natursteinkleber	Gebinde kg	Menge /Pal.	CHF/ Geb.
Mapei Mapestone basic, grau	25	40	65.50
Mapei Mapestone 1, weiss,	25	40	90.25
PCI Carraflex weiss	5	42	26.65
	25	42	97.00
PCI Carrament grau	25	42	54.75
PCI Carrament weiss	25	42	66.25



2.20

Ausfugprodukte für Natursteine	Gebinde kg	Gebinde/ Palette	einzel CHF/ Gebinde	Palettweise CHF/Gebinde
Cermix Cermijoint TX, mittelgrau	25	40	42.50	
Cermix Cermijoint Rustic GK, 5-50mm steingrau, euvillestein (beige)	25	42	39.50	37.00
Fugensand STONES ECO, 100% ökologisch, wasserdurchlässig, basalt, beige oder grau	25	48	48.00	
PCI Carrafug, Natursteinfuge, sandgrau, jurabeige, perlgrau, anthrazit, carraraweiss	5		32.95	
PCI Pavifix CEM ROC Pflastermörtel (5-50 mm)	25	42	23.50	
PCI Pavifix 1K Extra, grau/beige/anthrazit	25	24	115.00	
Baumit Pflasterfugenmörtel grau, 4-20mm	25	56	12.80	
PCI Pavifix PU Set, grau/beige (wasserdurchlässig)	20,9		136.90	
PCI Pavifix, Sandmischung einzeln	20	56	52.40	
PCI Pavifix V, Vorgrundierung	5		127.60	
Acosim TKB 100 Trasskalk-Fugenvergussmörtel, wasserdurchlässig	25	40	36.00	33.50
Acosin Contour grau, 0,2-2,0mm	25	40	53.00	50.00



2.21

Fugendichtmassen		Gebinde	Stk/Karton	CHF/Stk
Mapei Mapesil AC Silikon	silbergrau, mittelgrau, zementgrau, anthrazit	310 ml	12	9.56
PCI Fugendicht, Acryl	weiss	310 ml	12	7.04
PCI Adaptol (Acryldichtmasse)	weiss, grau	310 ml	12	9.19
PCI Carraferm (für Natursteine)	anthrazit, basalt, carraraweiss, jurabeige, perlgrau, sandgrau, zementgrau, transparent	310 ml	12	25.04
PCI Elritan 100 (PU) für Hochbaufugen	betongrau, hellgrau, weiss, zementgrau	600 ml	15	23.42
PCI Elritan 140 (PU) für Bodenfugen	sandgrau, betongrau	400 ml	15	19.36
PCI Silcofug E für Sanitär-fugen	alle PCI Farben	310 ml	12	13.76
PCI Silcoferm S	alle PCI Farben	310 ml	12	23.64
Sakret REFUG 2K elastische Fugenvergussmasse 2K (lösemittelfrei) reaktiv aushärtend, nach 30 min hart, ab 3 mm	Kartusche Kessel	425 g 5 kg		47.75 120.20
Sika Swell S-2 neu aufquillender Dichtstoff	oxidrot	310 ml		26.80
Sikaflex -11FC plus, Kleb- & Dichtstoff		300 ml	12	15.60



Zubehör		Gebinde	Stück/ Karton	CHF/Stk	Karton CHF/Stk
PCI Elastoprimer 110		1000 ml			71.21
PCI Elastoprimer 145		250 ml			68.06
PCI Elastoprimer 150		250 ml			59.48
PCI Elastoprimer 165		250 ml			53.63
PCI Elofix zum reinigen	20 x 65 x 80 mm				28.51
PCI Entöler-Paste		1 l			51.10
PCI Glättmittel		1 l			20.74
		5 l			56.80
PCI Univerdünner		1 l			40.05
		5 l			157.85
PE-Fugenfüllprofile rund	Stärke: 6 mm		100	0.65	0.30
	10 mm		100	0.70	0.38
	15 mm		100	0.90	0.60
	20 mm		50	1.20	0.75
	25 mm		50	2.00	1.40
PCI RT 930 Reinigungstücher		in Box			29.62
PCI Spezialreiniger Epoxi		5 l			219.80

2.22 Profile

Schlüter Wand- und Bodenabschlüsse	Länge		CHF/m'
Schlüter-Jolly-P 60 BW brillantweiss	250 cm	25 m/Bd	3.27
Schlüter-Jolly-P 80 BW brillantweiss	250 cm	25 m/Bd	3.54
Schlüter-Jolly-P 100 BW brillantweiss	250 cm	25 m/Bd	3.70
Schlüter-Rondec-Pro 60 BW brillantweiss	250 cm	25 m/Bd	3.54
Schlüter-Rondec-Pro 80 BW brillantweiss	250 cm	25 m/Bd	3.70
Schlüter-Rondec-Pro 100 BW brillantweiss	250 cm	25 m/Bd	3.98
Schlüter-Schiene AE 80 alu eloxiert	250 cm	25 m/Bd	6.66
Schlüter-Schiene AE 100 alu eloxiert	250 cm	25 m/Bd	7.09
Schlüter-Schiene AE 110 alu eloxiert	250 cm	25 m/Bd	7.57
Schlüter-Schiene E 45 Edelstahl V2A	250 cm	25 m/Bd	12.47
Schlüter-Schiene E 80 Edelstahl V2A	250 cm	25 m/Bd	13.35
Schlüter-Schiene E 90 Edelstahl V2A	250 cm	25 m/Bd	13.77
Schlüter-Schiene E 100 Edelstahl V2A	250cm/300 cm	25 m/Bd	14.02
Schlüter-Schiene E 110 Edelstahl V2A	250 cm/300 cm	25 m/Bd	14.80
Schlüter-Schiene E 125 Edelstahl V2A	250 cm	25 m/Bd	15.30
Schlüter-Schiene E 150 Edelstahl V2A	250 cm	25 m/Bd	16.75
Schlüter-Schiene E 200 Edelstahl V2A	250 cm	25 m/Bd	18.46
Schlüter-Rondec-E RO 80 Edelstahl V2A	250 cm	25 m/Bd	17.69
Schlüter-Rondec-E RO 100 Edelstahl V2A	250 cm/300 cm	25/30 m/Bd	18.92
Schlüter-Rondec-E RO 110 Edelstahl V2A	250 cm	25 m/Bd	19.66
Schlüter-Rondec-E RO 125 Edelstahl V2A	250 cm	25 m/Bd	20.08
Schlüter-Quadec-E Q 90 Edelstahl V2A	250 cm	25 m/Bd	18.55
Schlüter-Quadec-E Q 100 Edelstahl V2A	250 cm	25 m/Bd	18.92
Schlüter-Quadec-E Q 110 Edelstahl V2A	250 cm	25 m/Bd	19.35
Schlüter-Deco-SG 110 EB 12	250 cm	25 m/Bd	63.69
Schlüter-Deco-SG 110 EB 15	250 cm	25 m/Bd	68.04
Edelstahl gebürstet / für Glaselemente			

Ecken zu Wand- und Bodenabschlüssen		CHF/Stk.
Schlüter-Rondec Aussenecke ED/RO 80E	Edelstahl Imitat	4.29
Schlüter-Rondec Innenecke ID/RO 80E	Edelstahl Imitat	4.29
Schlüter-Rondec Aussenecke ED/RO 100E	Edelstahl Imitat	4.29
Schlüter-Rondec Innenecke ID/RO 100E	Edelstahl Imitat	4.29
Schlüter-Rondec Aussenecke ED/RO 110E	Edelstahl Imitat	4.29
Schlüter-Rondec Innenecke ID/RO 110E	Edelstahl Imitat	4.29
Schlüter-Quadec A/I-Ecke ED/Q 90E	Edelstahl Imitat	5.34
Schlüter-Quadec A/I-Ecke ED/Q 100E	Edelstahl Imitat	5.34
Schlüter-Quadec A/I-Ecke ED/Q 110E	Edelstahl Imitat	5.34



Profile Edelstahl gebürstet neu	Länge	CHF/m'
Alfer - Schiene E80 GB V2A Edelstahl gebürstet	250 cm	14.30
Alfer - Schiene E100 GB V2A Edelstahl gebürstet	250 cm	14.85
Alfer - Schiene E110 GB V2A Edelstahl gebürstet	250 cm	15.22
Alfer - Schiene E125 GB V2A Edelstahl gebürstet	250 cm	15.37
Alfer - Schiene E220 GB V2A Edelstahl gebürstet	250 cm	21.20

Fliesenmagnete	CHF/Stk.
Schlüter-Rema Fliesenmagnete (4 Magnetplatten und 4 Gegenstücke)	12.10

2.23 Bauplatten, Wannenelemente

BMR-Aktionsbauplatten und Wannenelemente	Format cm	Platten (Stk.)/m ² pro Palette	palettweise CHF/m ²	einzel CHF/m ²
Stärke 04 mm	130 x 60 cm	140/109,2 m ²	19.50	20.50
06 mm	130 x 60 cm	140/109,2 m ²	19.50	20.50
10 mm	260 x 60 cm	50/78,0 m ²	20.20	21.20
12,5 mm	260 x 60 cm	50/78,0 m ²	20.50	21.50
20 mm	260 x 60 cm	50/78,0 m ²	22.70	23.80
30 mm	260 x 60 cm	36/56,16 m ²	24.40	25.50
40 mm	260 x 60 cm	36/56,16 m ²	26.80	28.00
50 mm	260 x 60 cm	26/40,56 m ²	29.60	30.80
80 mm*	260 x 60 cm	20/30,0 m ²	33.00	35.00
Wannenelement 20 mm, lang	177 x 60 cm	30 Stk		49.00/Stk
Wannenelemente 20 mm, kurz	73 x 60 cm	30 Stk		25.30/Stk
Wedi Wannenelement 30mm, lang	180 x 60 cm	30 Stk		82.15/Stk

Winkel	Stärke mm		Stk/Palette	CHF/Stk.
Winkel, R 15	20	15 x 15 x 250	60	56.40
Winkel, R 20	20	20 x 20 x 250	40	81.65
Winkel, R 30	20	30 x 30 x 250	40	97.00
Winkel, R 40	20	40 x 20 x 250	40	97.00
PCI Pecedur-Halteteller verz.		Ø 50 mm	500	0.98

2.24 Entkopplung

Entkopplungs- und Dichtungsbahnen	Rollenlänge	CHF/m ² offen	CHF/m ² ganze Rollen
Mapei Mapeguard WP 200, 1 m breit	30 m	-	478.80/Rolle
Mapei Mapetex 1 m breit, Entkopplungsvlies	50 m	-	16.74
Mapei Mapesilent Roll 8 mm, 1,0 m breit	10 m	-	15.44
Mapei Mapesilent Band, R50/100 mm	50 m	-	165.50/Rolle
Mapei Mapeguard UM 35 Entkopplungsmatte, wasserdicht, rissüberbückend	30 m		18.63
PCI Pecilastic 1m breit, Entkopplungsgewebe	50 m	19.90	19.21
PCI Pecilastic E, Entkopplungsbahn innen	5 m	-	15.55
Schlüter DITRA 25, 30x1m	30m ²		21.60
PCI Pecilastic U 1m breit, Abdichtungs- & Entkopplungsbahn	5 m	-	26.36
PCI Pecilastic W 1m breit, flexible Abdichtungsbahn	30 m		27.33

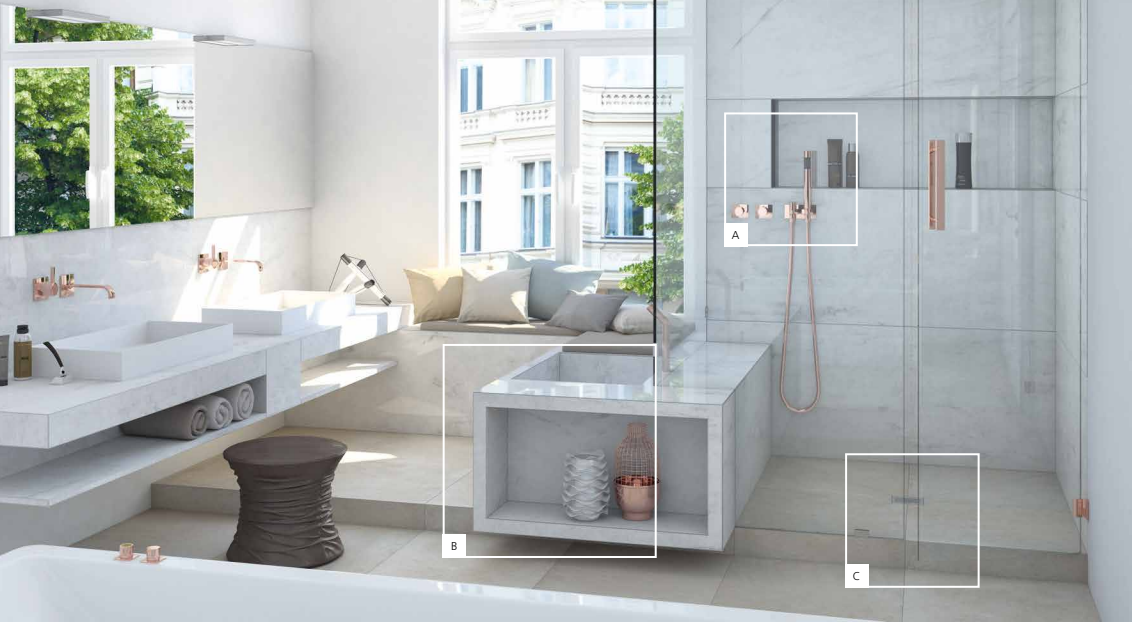

Die wedi Systemwelt

für die Gestaltung schöner und sicherer Bäder

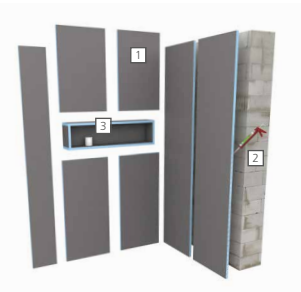

A Systemaufbau Duschwandlösung

Verwendete Produkte

- 1 wedi Bauplatten
- 2 wedi 610, Kleb- und Dichtstoff
- 3 Armierband

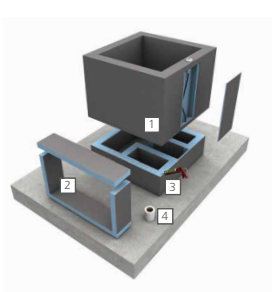

B Systemaufbau Fußbecken

Verwendete Produkte

- 1 wedi Fußbecken
- 2 wedi Bauplatten
- 3 wedi 610, Kleb- und Dichtstoff
- 4 Armierband

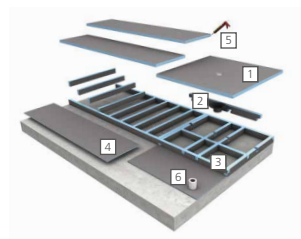

C Systemaufbau Sockelkonstruktion

Verwendete Produkte

- 1 wedi Fundo Primo
- 2 wedi Fundo Ablauf
- 3 wedi Fundo Primo Easy Set
- 4 wedi Bauplatten
- 5 wedi 610, Kleb- und Dichtstoff
- 6 Armierband

Thumag AG
Postfach 103 • Alleestr. 9 • CH-9326 Horn
Tel. +41 (0) 71 844 40 40 • Fax +41 (0) 71 844 40 49 • info@thumag.ch • www.thumag.ch



alle Preise exkl. MwSt

PCI Entkoppelungsplatten*	Menge/Pack m ²	CHF/Pack
PCI Polysilent 4 mm	4.32	105.43
PCI Polysilent 7 mm	4.32	127.86
PCI Polysilent Plus, 10 mm	3.60	199.20

* nur auf Bestellung

Entkoppelungs- und Trittschallplatten für den Innenbereich	Stärke mm	Abmessung L x B cm	Verpackungseinheiten Stk/ m ² / m ² Palette	Paketweise CHF/m ²
Thumaphon N300	4	100 x 60	20 / 12,0 / 180	* 16.95
Thumaphon N400	4	100 x 60	15 / 9,0 / 135	19.50
Thumaphon N700	7	100 x 60	9 / 5,4 / 135	24.45
Thumaphon N900	9	100 x 60	6 / 3,6 / 64,8	28.45
Thumaphon N1200	12	100 x 60	5 / 3,0 / 45	36.90
Thumaphon N1500	15	100 x 60	4 / 2,4 / 36	41.90
Thumaphon Plus 10mm Trittschallverbesserungsmass bis 16dB	10	100 x 60	6 / 3,6 / 36	* 47.80
Thumaphon Flex acoustic (Rolle)	4	1,2 x 7m	Rolle / 8,4 / 126	* 23.90
Mapei Unireno NG	4	100 x 60	10 / 6 / 60	16.08
	7			19.64
	9			21.79
	12			26.40
	15			28.01

* nicht immer vorrätig!

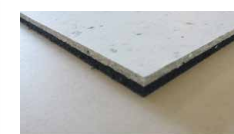
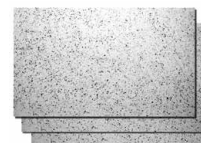

+3% TZ

2.25 Montageschaum

Montageschaum	Gebinde ml	Stk/ Karton	CHF/Stk
Mapei MapePur All in One Foam	750	12	13.75
Mapei MapePur Multi Adhesive Foam G Klebeschaum	750	12	15.06
Mapei MapePur Fire Foam M	750	12	17.83
Mapei MapePur Universal Foam G Füllschaum	750	12	13.25
PB 235 PU-2K-Rapidschaum	400	12	18.90
Brunnenschaum 1K wasserdicht	750	12	15.50



2.26

Blähton	Gebinde Liter	Körnung mm	Säcke/ Palette	palettw. CHF/Sack	einzel. CHF/Sack
Ricoter Blähton braun*	50	8-16	30	18.65	20.50

* Blähton im Big-Bag -> Kapitel 4.3x



2.27 Bausteine und Zubehör

2.27.1 Swiss-Modul-Backsteine 	Stk/Palette	palettweise ab Lager CHF/1000 Stk	einzel ab Lager CHF/1000 Stk
B 7,5/19, 29/7,5/19 cm	180	1620.00	1900.00
B 10/14, 29/10/14 cm	240	1750.00	2050.00
B 10/19, 29/10/19 cm	180	1900.00	2300.00
B 12,5/14, 29/12,5/14 cm	192	2150.00	2420.00
B 12,5/19, 29/12,5/19 cm	144	2300.00	2700.00
B 15/14, 29/15/14 cm	168	2550.00	2850.00
B 15/19, 29/15/19 cm	126	2780.00	3100.00
B 17,5/14, 29/17,5/14 cm	144	3050.00	3400.00
B 17,5/19, 29/17,5/19 cm	108	3300.00	3650.00
B 20/19, 29/20/19 cm	90	3750.00	4200.00
Ausgleichssteine			
B 10/6,5/29 cm	465	1600.00	1850.00
B 10/9/29 cm	360	1650.00	1900.00
B 12,5/6,5/29 cm	309	1900.00	2150.00
B 12,5/9/29 cm	288	1950.00	2200.00
B 15/6,5/29 cm	249	2320.00	2570.00
B 15/9/29 cm	252	2400.00	2650.00
B 17,5/6,5/29 cm	206	2650.00	2900.00
B 17,5/9/29 cm	216	2700.00	2950.00

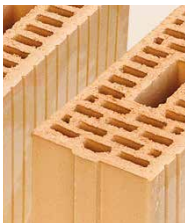

Bedarf/m²: Swiss-Modul 14: 23 Stk/m²
 Swiss-Modul 19: 16,7 Stk/m²

2.27.2 Zwischenwandplatten 	Stk/Palette	palettweise ab Lager CHF/1000 Stk	einzel ab Lager CHF/1000 Stk
ZP 6, 40/25/6 cm	160	6400.00	6800.00
ZP 8, 40/25/8 cm	116	7600.00	8000.00



2.27.3 Tonsturz-Bretter (Stahlton) 	Lagerlängen	ab Lager CHF/m ¹
7,5/6,5 cm	1 – 1,6 m	21.80
10/6,5 cm	1 – 2,4 m	21.80
12,5/6,5 cm	1 – 3,6 m	26.00
15/6,5 cm	1 – 3,6 m	32.40
17,5/6,5 cm	1 – 3,6 m	37.30
20/6,5 cm	1 – 2,6 m	50.00



2.27.4 Kalksandsteine 	Grösse in cm	Stück / Palette	Palettweise Abgeholt CHF/1000 Stk	Einzel Abgeholt CHF/1000 Stk
K 10/19	25x10x19	112	2280.00	2850.00
K 10/14	25x10x14	168	1690.00	2100.00
K 10/6,5	25x10x6,5	216	1350.00	1700.00
K 12/19	25x12x19	96	2380.00	2980.00
K 12/14	25x12x14	144	1760.00	2200.00
K 12/6,5	25x12x6,5	288	1550.00	1950.00
K 12/9	25x12x9	192	1800.00	2200.00
K 15/19	25x14,5x19	80	2900.00	3600.00
K 15/14	25x14,5x14	120	2100.00	2650.00
K 15/6,5	25x14,5x6,5	240	1850.00	2350.00
K 15/9	25x14,5x9	160	2200.00	2800.00
K 18/19	25x18x19	64	3650.00	4550.00
K 18/14	25x18x14	96	2700.00	3350.00
K 18/6,5	25x18x6,5	192	2350.00	2900.00
K 18/9	25x18x9	128	3000.00	3700.00
K 20/14	25x20x14	72	3350.00	4200.00
K 20/19	25x20x19	64	4580.00	5700.00



Bedarf/m²: KN 14cm: 26 Stk/m² KN 19cm: 19 Stk/m²
 Halbe Steine (Würfel) auch an Lager!



2.27.5 Betonstürze	Baulängen cm	Gewicht kg/m	ab Lager CHF/m ¹
10 x 6,5 cm	103/129/155/181/207	15	29.80
12 x 6,5 cm	103/129/155/181/207	19	34.10
14,5 x 6,5 cm	103/129/155/181/207	23	41.90
10 x 14 cm	103/129/155/181/207	35	58.00
12 x 14 cm	103/129/155/181/207	40	75.00
14,5 x 14 cm	103/129/155/181/207	48	86.30
18 x 6,5 cm	103/129/155/181/207	24	47.10
18 x 14 cm	103/129/155/181/207	60	101.60
20 x 14 cm	103/129/155/181/207	65	108.70



2.27.6 Ytong Gasbetonsteine/Platten	Grösse cm	m ² /pal	Palettweise CHF/m ²	Einzel CHF/m ²
Rapido 5 cm (460 kg/m ³)	60x37,5	21,6	17.80	20.25
Rapido 7 cm (460 kg/m ³)	60x37,5	14,4	26.20	30.15
Rapido 10 cm (460 kg/m ³)	60x37,5	10,8	33.80	38.90
P 12,5 cm, mit Nut-und Feder	60 x 25	9.00	42.40	48.80
P 15,0 cm, mit Nut-und Feder	60 x 25	7.20	51.00	58.80
P 17,5 cm, mit Nut-und Feder	60 x 25	6.30	58.30	67.05
P 20,0 cm, mit Nut-und Feder	60 x 25	5.40	67.00	77.05
P 25,0 cm, mit Nut-und Feder	60 x 25	4.50	86.00	99.00
Ytong Dünnbettmörtel Fix N240	15 kg	44 S.		38.00 /S.



alle Preise exkl. MwSt

2.27.7 Schalungssteine Schalit (für Kellerwände etc.)	Stück pro Palette	Stk/m ²	CHF/Stk
15 cm stark, 40 x 25 cm 	42	10	5.75
17,5 cm stark, 50 x 25 cm Import	48	8	5.20
20 cm stark, 40 x 25 cm 	36	10	6.25
24 cm stark, 50 x 24 cm Import	40	8	5.70
30 cm stark, 50 x 24 cm Import	28	8	6.80



2.27.8 Mauerwerksbewehrung und Zubehör	Stk/Karton	Stk	Grösse	kartonweise CHF
Eckbügel 4 mm E 45, rostfrei		25	45/45 cm	5.80/Stk
Z-Bügel 4 mm, Z 22, rostfrei		50	22 cm lang	2.80/Stk
Z-Bügel 4 mm, Z 24, rostfrei		50	24 cm lang	3.00/Stk
Armorfer Lagerfugenarmierung verzinkt	4/50	50	5 x 305 cm	3.90/m¹
	4/80	50	8 x 305 cm	3.95/m¹
	4/100	50	10 x 305 cm	4.00/m¹
Lagerfugenarmierung Armofer Inox	Inox 4/50	25	5 x 305 cm	4.75/m¹
	Inox 4/80	25	8 x 305 cm	4.85/m¹
	Inox 4/100	25	10 x 305 cm	5.20/m¹
Zwischenwandanschluss Albanese® verzinkt, klappbar		50		4.90/Stk
Fibre Net Zwischenwandanschlussstr.	8.5x40cm	100		3.00/Stk

2.28 Trockenbau/Gipsplatten

2.28.1 Vollgipsplatten Alba 	Format cm	m ² /Palette	ganze Paletten CHF/m ²	einzel ab Lager CHF/m ²
Alba Vollgipsplatten 2,5 cm	50x100	20	17.00	21.50
Alba Vollgipsplatten 4 cm	50x100	12	23.00	28.70
Alba Vollgipsplatten 6 cm	66,6x50	12	34.40	42.80
Alba Vollgipsplatten 8 cm	66,6x50	10	41.30	52.00
Alba Vollgipsplatten 10 cm	66,6x50	8	49.30	61.70
Alba Vollgipsplatten Hydro 2,5 cm	50x100	20	22.40	27.50
Alba Vollgipsplatten Hydro 4 cm	50x100	12	30.10	37.30
Alba Vollgipsplatten Hydro 6 cm	66,6 x 50	12	44.70	55.70
Alba Vollgipsplatten Hydro 8 cm	66,6 x 50	10	53.90	67.30
Alba Vollgipsplatten Hydro 10 cm	66,6 x 50	8	64.20	80.00
Alba Presskorkprofile	Grösse mm	Länge cm	CHF per m	
Wandstärke 40mm	5 x 34	100	7.20	
Wandstärke 60mm	5 x 52	100	8.70	
Wandstärke 80mm	5 x 72	100	10.90	
Wandstärke 100mm	5 x 92	100	11.50	



alle Preise exkl. MwSt

2.28.2 Gipskartonplatten	Format cm	m ² /Palette	ganze Paletten CHF/m ²	einzel CHF/m ²
Gipskartonplatten 9,5 mm	125x250	187,5	5.00	6.50
Gipskartonplatten 12,5 mm	60x260	78,0	6.40	7.80
	125x200	125,0	5.35	6.70
	125x250	156,2	5.35	6.70
Gipskartonplatten 15 mm	125x250	125,0	8.30	11.00
Gipskartonplatten 12,5 mm imprägniert	125x250	156,2	9.00	10.50
	62,5x260	78,0	9.20	11.50
Massivbauplatten 25 mm	62,5x260	39,0	12.50	14.50
Massivbauplatten 25 mm imprägniert	62,5x200	30,0		
	62,5x250	39,0	17.00	19.00

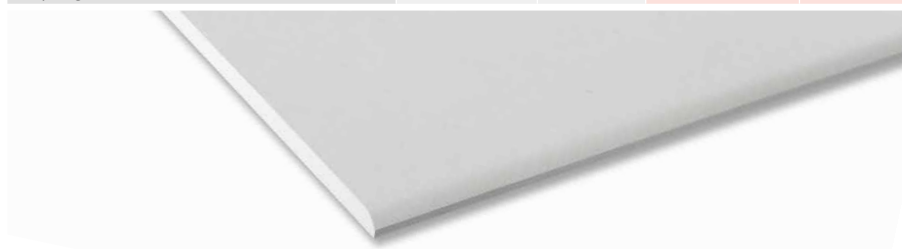

2.28.3 Fermacell Produkte	Format	Stk/Palette	ganze Paletten CHF/m ²	einzel CHF/m ²
Fermacell-Platten 10 mm	100x150cm	75	11.80	13.80
Fermacell-Platten 12,5 mm	100x150 cm	60	14.00	15.00
Fermacell Estrich-Elemente 20 mm	50x150 cm	74		29.50
	50x150 cm	60		33.00
Fermacell-Spachtel	5 kg			17.00
Fermacell-Ausgleichsschüttung 0-4mm	50 liter	30	19.50	21.00

2.29 Trockenbau-Zubehör

2.29.1 Putzprofile	Längen m	Stk/Bund	bundweise CHF/m ¹	einzel CHF/m ¹
Alu-Eckputzprofil, Innen, 24/24 mm	2,5	25	1.40	1.60
Trim-L Abschlussprofil bverz. 13/23 mm	2,75	10	2.20	2.60
Kantenprofil verz., Innen	2,5	50	1.40	1.60
Abschlussprofil verz., Innen 9 mm	2,5/3,0	25	2.30	2.80
Abschlussprofil verz., Innen 6 mm	2,5/3,0	25	2.00	2.50
Kantenrichtwinkel, Aussen 8 mm mit PVC-Überzug	2,5/3,0	50	2.60	3.00
Schnellputzprofil verz., Innen 10 mm, 1105	2,5	50	1.40	1.60
Schnellputzprofil verz., Innen 6 mm, 1106	2,5	50	1.20	1.40
Kantenrichtwinkel verz., 10 mm mit PVC-Kante	2,5/3,0	15	4.40	5.00

2.29.2 Profile	Dimension mm	Länge m	Stk/Bund	Bundweise CHF/m ¹	einzel CHF/m ¹
CW-Ständerprofile	50			4.60	5.70
Längen: 2,6/2,75/3,0/3,5/4.0 m	75			5.20	6.50
	100			6.00	7.50
CD-Deckenprofile 60/27 mm	60/27		12	4.00	6.00
Längen: 3,10/4,0 m					
UD-Randprofil 27/28/27 mm			16	3.00	4.20
Länge: 3.0 m					
UW-Randprofile verz.	50		8	6.00	7.00
Länge: 4.0 m	75		8	6.60	7.80
	100		8	7.20	8.40
UA-Türprofile 2,0 mm stark	48		8	13.00	17.00
Längen: 2,5/3,0 m	73		8	15.80	19.50
	98		8	18.50	22.80
Trennstreifen einseitig	50	30			22.00/Rle
1 cm selbstklebend, weiss,					
3mm stark					
Filz-Trennstreifen beidseitig klebend	43	20			16.50/Rle
	68	20			25.00/Rle
	93	20			33.50/Rle

Andere Knauf-Profile kurzfristig lieferbar

2.29.3 Profix-Schnellbauschrauben	für Werkstoff	Stk/Paket	CHF/Paket
mit Trompetenkopf, geölt, schwarz			
3,9 x 11 mm (BSP) Feingewinde	Metall	1000	36.40
3,5 x 25 mm (SP) Feingewinde	Metall	1000	26.80
3,5 x 35 mm (SP) Feingewinde	Metall	1000	32.40
3,5 x 45 mm (SP) Feingewinde	Metall	1000	41.80
3,9 x 55 mm (SP) Feingewinde	Metall	500	27.50
3,9 x 25 mm (SPG) Grobgewinde	Holz	1000	26.80
3,9 x 35 mm (SPG) Grobgewinde	Holz	1000	32.40
3,9 x 45 mm (SPG) Grobgewinde	Holz	1000	41.80
3,9 x 55 mm (SPG) Grobgewinde	Holz	500	55.00
4,2 x 75 mm (SPG) Grobgewinde	Holz	250	25.50
5,5 x 38 mm (SPGG) Grobgewinde	Gips/Gips	500	42.50

2.30 Glasfasergewebe

2.30.1 Glasfasergewebe	Maschenweite mm	Rollenlänge m	Farbe	CHF/Rolle
5 cm selbstklebend	3 x 3	50	weiss	7.80
10 cm selbstklebend	3 x 3	90	weiss	19.90
100 cm 150 g/m ² (PF 350)	4 x 4	50	weiss	98.00
110 cm 200 g/m ² (Marmoran KA61)	8 x 8	50	bordeauxrot	189.75

2.30.2 Glasfasergewebe-Eckwinkel mit PVC-Verstärkung	Länge m	m/Paket	paketweise m ¹	einzel m ¹
10 cm x 23 cm	2,5	125	1.50	2.00

2.31 Taumittel/Salz	Gebinde	Säcke/ Pal.	Palettweise CHF/Sack	einzel CHF/Sack
Taumittel/Streusalz				
Streusalz Taufix 	25 kg	32	* 12.20	* 13.75
	10 kg	72		* 7.00
	Kessel 12.5 kg	56		* 12.86
Ice-Remover x-73	22.5 kg Kessel 12 kg	36		* 61.55 52.25
REOSAL Regeneriersalz	Tablets 25 kg	40	17.00	18.50
	fein 25 kg	32	13.80	14.80



*** Vorsaison-Bestellaktion bis 30.8.2024 zu reduzierten Preisen, fragen Sie uns an!**

2.32 Sand & Kies	to/m ³	ab Lager * CHF/m ³
2.32.1 Sand/Kies		
Nur in Big-Bags lieferbar! Kein Loseverkauf!		
Schlemmsand/Spielsand	1,35	80.00
Zementsand 0 – 4 mm	1,50	87.00
Sand-Kiesmischung 0 – 16 mm (0/32mm)	1,75	98.00
Kies/Gartenkies 8 – 16 mm	1,63	88.00
Kies/Sickerkies 16 – 32 mm	1,68	88.00
Kies/Sickerkies 32 – 45 mm	1,65	86.00
Splitt 3 – 6 mm	1,35	92.00
Splitt 6 – 8 mm	1,35	92.00

Liefermengen: 0,5/0,75/1,0 m³

➔ * Sand und Kies nur in Big-Bags à 1 m³ lieferbar, ab Lager-Preise zuzüglich CHF 25.– Abfüllgebühr, 15.– pro Big-Bag. (Big-Bags werden nicht zurückgenommen). Zuschläge Netto!

➔ **Offenverkauf ist nicht möglich!**



2.32.2 Misapor	Inhalt	kg/m ³	CHF/m ³	Stk/Pal.	einzel CHF/Stk	palettweise
Big-Bags leer, Neu, Einweg , Inhalt 1m ³ , Tragkraft 1500 kg				225	15.00	auf Anfrage
Schaumglasschotter Standard 10/75 mm im Big-Bag	2 m ³	190	173.00			
Einweg Misapor-Big-Bags (2 m ³)		Zuschlag	17.00			
	Inhalt	Stk/Pal.			einzel CHF/Stk	palettweise
Schaumglasschotter 10/25 mm im Sack (red. Rabatt)	50 l	36			25.44	21.00



2.33 Sand/Kies in Säcken

Sand und Kies in Säcken	Inhalt kg	S/Pal	ab 1 Palette CHF/Sack	einzel CHF/Sack
Zementsand 0 – 4 mm	25	48	7.80	8.90
Quarzsand 0,3 – 0,8, 0,8 – 1,6 oder 1,0 – 2,0 mm	25	42	13.00	16.00
Sand-Kiesmischung 0 – 16 mm	25	48	7.80	8.80
Schlemmsand (Spielsand)	ca 25	48	6.90	7.80
Splitt 2 – 5 mm	ca 25	48	6.90	7.80
Fugensplitt dunkelgrau 1 – 2 mm	25	48	8.50	9.80
schwarz 1 – 3 mm	25	48	9.80	12.00
Splitt Nero Ebano 8 – 12 mm	ca 25	48		22.30
Marmor Splitt weiss 8 – 12 mm	ca 25	48		22.30
Gartenkies 8 – 16 mm, sauber 	ca 25	48	7.90	8.60
Sickerkies 20 – 40 mm	ca 25	48	8.00	9.00
Marmor-Rundkies weiss 7 – 15 mm, 20 – 40 mm, 40 – 60 mm	ca 25	48	18.80	19.55

2.34 Kaltbelag/Oelbinder

Kaltbelag/Bitumenreparaturmörtel 	Inhalt	Stk/Pal	einzel CHF
Maape-Asphalt Repair 0/8 mm	25 kg	24/Pal	75.25
Sakret Grundierung E, zu Kaltbelag (Staubbinder, lösemittelfrei)	5 Liter		42.30
Sakret Refug 2K	5 kg		126.25
Kartusche	0,425 kg		47.05
Oelbinder Absolyt Typ IIIIR zugelassen auch für Verkehrsflächen	16 kg/S	21 S/Pal	22.50



2.35 Armierungsstahl und Zubehör

2.35.1 Armierungseisen

		CHF/m
Armierungsstahl D 8 mm 5,0 m lang	B500B (0,395 kg/m ³)	0.97
Armierungsstahl D 10 mm 5,0 m lang	B500B (0,617 kg/m ³)	1.52
Armierungsstahl D 12 mm 5,0 m lang	B500B (0,888 kg/m ³)	2.20
Armierungsstahl D 14 mm 5,0 m lang	B500B (1,210 kg/m ³)	3.00
Armierungsstahl D 16 mm 5,0 m lang	B500B (1,580 kg/m ³)	3.56
Armierungsstahl D 20 mm 5,0 m lang	B500B (2,470 kg/m ³)	6.10



2.35.2 Armierungsnetze

		CHF/m ²
Armierungsnetz K 188 150/150/6 mm	2 x 5 m (30,2 kg/Stk)	9.90
Armierungsnetz K 335 150/150/8 mm	2 x 5 m (53,7 kg/Stk)	15.80



2.35.3 Unterlagsbodennetze verzinkt, zum einlegen in Überzug

	Grösse	CHF/Netz	ab Lager
50mm x 50mm x 2mm Maschenweite	2 x 1 m		9.65

 Alle diese Armierungsprodukte sind bei uns an Lager!

2.35.4 Armierungsabstand- und Bewehrungskörbe

	Ø mm	Länge cm	CHF/Meter
Distanzkörbe Kufu, 100 mm		250	5.90/m
Distanzkörbe Kufu, 150 mm		250	6.90/m
Distanzkörbe Kufu, 200 mm		250	7.00/m
Distanzkörbe Kufu, 240 mm		250	10.30/m
Distanzkörbe Kufu, 300 mm		250	10.30/m
Distanzkörbe Kufu, 380 mm		250	13.70/m
Distanzkörbe DK, 100 mm		250	5.90/m
Distanzkörbe DK, 150 mm		250	6.40/m
Distanzkörbe DK, 200 mm		250	7.00/m
Distanzkörbe DK, 240 mm		250	10.30/m
Bewehrungsanschluss ACITOP Typ 2 einschnittig, Deckenstärke variabel	10	125	28.64/m
Bewehrungsanschluss ACITOP Typ 22k zweischnittig, Deckenstärke 18-20 cm Teilung 15x15	10	83	50.20/m
Bewehrungsanschluss ACITOP Typ 26 zweischnittig, Deckenstärke 18-20 cm Teilung 15x15	10	125	43.58/m
Bewehrungsanschluss ACITOP Typ 40k zweischnittig, Deckenstärke 25 cm, Teilung 15x15	10	83	57.59/m
Bewehrungsanschluss ACITOP Typ 44 zweischnittig, Deckenstärke 25 cm, Teilung 15x15	10	125	45.43/m
Querkraftdorn ACIDORN, W.1.4362 Typ ADE 10	20 20	30 40	39.35/st 48.65/st
Gleithülse ACIDORN aus Kunststoff	20 20	16 21	4.05/st 4.25/st

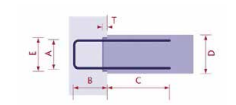
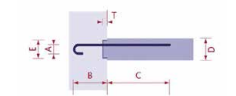
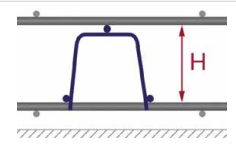
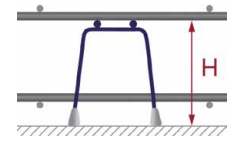

2.35.5 Drahtbinder

Bünde zu 1000 Stk, blank Länge in cm	einfache CHF/Bund	Profi Doppelbinder CHF/Bund
10	19.55	38.10
12	20.10	38.86
14	23.73	43.45
16	25.77	55.43



alle Preise exkl. MwSt

2.35.6 Zement-Unterlagsplättli	Menge/Sack	CHF/Sack
Stärke in mm		
25	300	37.75
30	250	36.60
35	250	39.00
40	250	42.00



2.35.7 Armierungsdistanzhalter (Drunterleisten) Kunststoff U	Länge m	Stk/Bund	CHF pro m ¹ bundweise	CHF pro m ¹ einzeln
Höhe in mm				
20	2,5	40	0.45	0.65
25	2,5	40	0.55	0.80
30	2,5	40	0.65	1.00
35	2,5	20	0.90	1.30
40	2,5	24	0.98	1.50



2.35.8 Schalungszubehör	Dimension	Stk/Paket	ganze Pakete CHF/Stk	einzeln CHF/m ¹
Kunststoff-Distanzrohre, 3 m lang	22 mm	17	1.31/m	1.55/m¹
Aufsteck-Konen K 22	22 mm	500	44.00/P.	
Verschlusszapfen Kunststoff PZ	22 mm	500	28.50/P.	
Gummizapfen GZ 22	22 mm	500	185.00/P.	
Anschlaghalterungen RISA 2000	15 cm 18 cm 20 cm 25 cm 30 cm 35 cm 40 cm	50	2.64 2.69 2.75 2.85 2.96 3.55 3.66	
UNI-Betonhülse Albanese®	Eimer	180	2.75	
Distanzhalter «Raschal»	12 cm 15 cm 18 cm 20 cm 25 cm 30 cm 35 cm 40 cm	100	52.90 59.92 57.08 57.00 63.25 71.84 76.00 83.58	
BegoFix N Abschalungswinkel		40	5.65	
BegoFix G Abschalungswinkel		40	6.25	
Mopex Plus	34/34/1020 mm	20	9.50/m¹	10.50/m¹

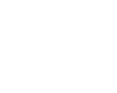

2.36 Betonrohre

alle Preise exkl. MwSt

Betonrohre		Baulänge in cm									
Ø cm	kg/m ¹	100	75 & 60	50	40	30	25	20	15	10	
10	27	30.60		30.60	30.60	30.60				30.60	
12	31	32.30		31.50							
15	41	35.10		32.40	32.40	32.40	32.40	32.40	32.40	32.40	
20	52	40.80	40.80	38.30	38.30	38.30	38.30	38.30	38.30	38.30	
25	68	49.20	49.20	44.30	44.30	44.30	44.30	44.30	44.30	44.30	
30	103	66.50	66.50	57.50	57.50	57.50	57.50	57.50	57.50	57.50	
40	170	94.00	94.00	79.00	79.00	79.00	79.00	79.00	79.00	79.00	
50	255	133.00	133.00	91.50	91.50	91.50	91.50	91.50	91.50	91.50	
60	355	156.00	156.00	111.00	111.00	111.00	111.00	111.00	111.00	111.00	
70	405	187.00	187.00	139.00	139.00	139.00	139.00	139.00	139.00	139.00	
80	530	223.00	223.00	163.00	163.00	163.00	163.00	163.00	163.00	163.00	
100	830	337.00	337.00	245.00	245.00	245.00	245.00	245.00	245.00	245.00	
125 ¹	1020	494.00	494.00	401.00			401.00				

Die mit ¹ bezeichneten Grössen sind nur auf Bestellung lieferbar. Eiformrohre, Ovalrohre und Konen gemäss Werkspreislisten.

2.37 Zementrohre mit Boden

Zementrohre mit Boden, flach	Höhe 55 cm kg/Stk	Höhe 105 cm kg/Stk	Höhe 55 cm CHF/Stk	Höhe 105 cm CHF/Stk
Ø cm				
30	58	109	101.00	108.00
40	100	185	141.00	154.00
50	155	280	179.00	208.00
60	225	400	210.00	254.00
70*	270	470	262.00	317.00
80	360	630	316.00	373.00
100	600	1020	425.00	545.00
125*	800	1310	675.00	805.00









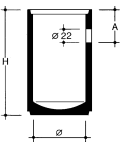

* nur auf Bestellung

2.37.1 Strassen-/Schlammsammler

Fugenlose Strassen-/Schlammsammler	Höhe in cm Aussparung bis Oberkante	SS	kg/Stk	CHF/Stk
bombierter Boden, 1 Aussparung Ø 22 cm				
Ø cm				
60	103	37	480	304.00
60	150	57	620	386.00
70	185	52	1010	755.00
70, inkl. eingegossenem Schachtfutter	185		1010	765.00



2.38 ACO-Schachtböden

ACO-Schachtboden Monolith 			Höhe H mm	hb mm	Gewicht kg	CHF/Stk	Typ
DN mm	dm mm	ds mm					
800	150		400	360	182	614.00	1 
800	200		450	410	200	614.00	
1000	150		400	360	270	798.00	
1000	200		450	410	295	798.00	
800	150	150	400	360	198	716.00	2 
800	200	200	450	410	215	716.00	
1000	150	150	400	360	280	894.00	
1000	200	200	450	410	310	894.00	
800	150	150	400	360	200	716.00	3 
800	200	200	450	410	205	716.00	
1000	150	150	400	360	280	894.00	
1000	200	200	450	410	325	894.00	
800	150	150	400	360	194	716.00	4 
800	200	200	450	410	220	716.00	
1000	150	150	400	360	285	894.00	
1000	200	200	450	410	315	894.00	
800	150	150	400	360	225	716.00	5 
800	200	200	450	410	210	716.00	
1000	150	150	400	360	285	894.00	
1000	200	200	450	410	315	894.00	
800	125	125	400	360	212	* 716.00	9 
800	150	150	450	410	220	* 716.00	
800	200	200	400	360	215	* 716.00	
1000	125	125	400	360	230	* 894.00	
1000	150	150	450	410	293	* 894.00	
1000	200	200	450	410	325	* 894.00	
Modelle 10 bis 13:							
800	150		400	360		716.00	10 
800	200		450	410		716.00	
1000	150		400	360		894.00	
1000	200		450	410		894.00	

* Lagerartikel

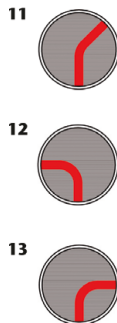
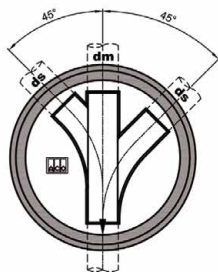

2.39 Zementrohr-Konen

Zementrohr-Konen, exzentrisch 	Höhe cm	Gewicht kg	CHF/Stk
Ø1/Ø2 in cm			
80/60	35	135	253.00
80/60	50	255	242.00
80/60	65	350	242.00
80/60	100	550	317.00
100/60	50	370	317.00
100/60	65	470	317.00
100/60	75	570	329.00
125/60 *	65	490	458.00

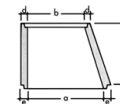

* nur auf Bestellung

2.40 Schachtrahmen

Schachtrahmen 74/70	Dimension cm	Gewicht kg	CHF/Stk
mit Aussparung LW 43/35 Klasse D 400	Ø 94/70 H 20	219	216.00

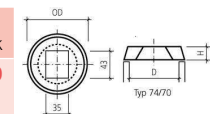

2.41 Zementrohr-Halbschalen

Zementrohr-Halbschalen 	Länge 50 cm CHF/Stk	kg/m	Länge 100 cm CHF/Stk
unarmiert, längshalbalbiert, Ø in cm			
10	23.20	13	30.40
15	26.60	20	34.50
20	32.40	26	41.40
25	35.60	34	46.50
30	48.60	51	67.00
40	69.00	84	91.50
50	92.00	124	138.00
60	123.00	155	179.00
80	179.00	260	243.00



2.42 Halbschalen-Gitterroste

Halbschalen-Gitterroste verz.	Maschenweite mm	CHF/Stk
Grösse in mm		
230 x 115	30 x 30	56.00
270 x 135	30 x 30	56.00
330 x 165	30 x 30	56.00
440 x 220	30 x 30	62.00
540 x 270	30 x 30	81.00
640 x 320	30 x 30	102.00
Haltebügel für Halbschalen, verzinkt		62.50/Paar



2.43 Rund-Gitterroste

Rund-Gitterroste verz.			
Ø in mm	Höhe mm	Maschenweite mm	CHF/Stk
330	30	30 x 30	91.00
440	30	30 x 30	114.00
540	30	30 x 30	137.00
640	30	30 x 30	162.00
850	30	30 x 30	223.00



2.44 Betondeckel

Betondeckel zu Zementrohr	A 15, versenkt, begehbar		B 125, PW befahrbar, aufgesetzt	
	Gewicht kg	CHF/Stk	Gewicht kg	CHF/Stk
10 cm Ø	1	35.60		
15 cm Ø	2	35.60		
20 cm Ø	3	38.70		
25 cm Ø	5	40.00		
30 cm Ø	8	45.80	24	95.50
40 cm Ø	13	57.50	45	130.00
50 cm Ø	23	80.50	75	193.00
60 cm Ø	40	105.00	100	200.00
70 cm Ø	58	128.00	135	276.00
80 cm Ø	73	167.00	182	325.00
100 cm Ø	120	209.00	300	476.00



2.45 Begu-Deckel

Begu-Deckel inkl. Betonfüllung zu Zementrohr, mit Geruchsverschluss, teilweise an Lager	Ø in cm	Raddruck 1 to / A15 CHF/Stk	Raddruck 3 to / B125 CHF/Stk	Raddruck 5 to / C250 CHF/Stk
60	161.00	185.00	266.00	
80		712.00		

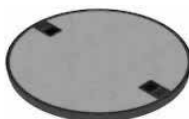

2.46 Bauguss

2.46.1 Boden- und Regenwasserabläufe		
Bodenabläufe «Stadt Basel»	Figur vonRoll	CHF/Stk
ohne Rückstaukugel	1784-010-00	1085.00
ohne Rückstaukugel, mit hinterem Einlauf	1785-010-00	1085.00
mit Rückstaukugel	1791-010-00	1250.00
mit Rückstaukugel & hinterem Einlauf	1792-010-00	1250.00
Ersatzzeimer zu Modell «Stadt Basel»		143.00
Gummikugel als Ersatzteil		159.00



Alle anderen Abläufe auf Bestellung gemäss Handbüchern von Aco und VonRoll

2.46.2 Gussdeckel geschlossen VonRoll				
	Nennweite	Raddruck	Ab Lager. Figur vonRoll	CHF/Stk
mit Handgriff	150 mm	bis 5 to	2613-015-00	75.00
mit Handgriff	700 mm	5 to	2613-070-00	626.00
mit Handgriff	1000 mm	5 to	2613-100-00	1615.00



2.46.3 Gussdeckel geschlossen vonRoll				
	Nennweite	Raddruck	Ab Lager. Figur vonRoll	CHF/Stk
verschr. für Innendruck BS	600 mm	Kl. C250	2646-060-07	950.00
verschr. für Innendruck BS	800 mm	Kl. C250	2646-080-07	2100.00
geruchdicht, verschraubt	1000 mm	5 to	2661-100-03	1905.80



2.46.4 Gussdeckel geschlossen ACO				
	Nennweite	Raddruck (Klasse)	ACO-Modell	CHF/Stk
Mit Kombigriff	20 cm	A15/B125	5B20.11.11	111.00
Mit Kombigriff, verschraubt	20 cm	A15/B125	5B20.11.12	310.00
Mit Kombigriff, Geruchsverschluss	25 cm	A15/B125	5B25.17.11	179.00
Mit Kombigriff	30 cm	A15/B125	5B30.11.11	141.00
Mit Kombigriff, verschraubt	30 cm	A15/B125	5B30.11.12	356.00
Mit Kombigriff	40 cm	A15	5A40.11.11	186.00
Mit Kombigriff	40 cm	B125	5B40.11.11	210.00
Mit Kombigriff, verschraubt	40 cm	B125	5B40.11.12	450.00
Mit Kombigriff	50 cm	A15	5A50.11.11	234.00
Mit Kombigriff	50 cm	B125	265.00	265.00
Mit Kombigriff, verschraubt	50 cm	B125	5B50.11.12	519.00
Mit Kombigriff	60 cm	A15	5A60.11.11	257.00
Mit Kombigriff	60 cm	B125	5B60.11.11	294.00
Mit Kombigriff, verschraubt	60 cm	A 15	5A60.11.12	533.00
Mit Kombigriff, verschraubt	60 cm	B125	5B60.11.12	574.00
Mit Kombigriff, Geruchsverschluss	60 cm	C250	5C60.17.11	526.00
Mit Kombigriff, verschraubt, Geruchsverschluss	60 cm	C250	5C60.11.12	765.00
Mit Kombigriff	60 cm	D400	1D60.11.61	815.00
Mit Kombigriff, verschraubt, Geruchdicht	60 cm	D400	1D60.11.62	922.00
Mit Kombigriff	80 cm	A15	5A80.11.11	889.00
Mit Kombigriff	80 cm	B125	5B80.11.11	918.00
Mit Kombigriff, verschraubt,	80 cm	A15	5A80.11.12	1189.00
Mit Kombigriff, verschraubt,	80 cm	B125	5B80.11.12	1251.00



Aufpreis für Standardbeschriftung (ACO) montiert

+45.00/Stk.



2.46.5 Gussdeckel gelocht, Roste, vonRoll				
	Nennweite	Raddruck	Ab Lager. Figur	CHF/Stk
gelocht, flach	150 mm	1/5 to	2815-015-00	64.50
gelocht, gewölbt/flach	800 mm	B125	BGS 625-80	650.00
gelocht, mit Verriegelung	500 mm	B125	2815-050-03	509.00



2.46.6	Gussdeckel gelocht, Roste, ACO	Nennweite	Raddruck (Klasse)	ACO-Modell	CHF/Stk
	Gussrost	20 cm	A15/B125	4B20.11.13	124.00
	Gussrost	25 cm	A15	4A25.11.13	124.00
	Gussrost	25 cm	B125	4B25.11.13	141.00
	Gussrost	30 cm	A15	4A30.11.13	141.00
	Gussrost	30 cm	B125	4B30.11.13	157.00
	Gussrost	40 cm	A15	4A40.11.13	186.00
	Gussrost	40 cm	B125	4B40.11.13	218.00
	Gussrost	50 cm	A15	4A50.11.13	234.00
	Gussrost	50 cm	B125	4B50.11.13	247.00
	Gussrost	60 cm	A15	4A60.11.13	257.00
	Gussrost	60 cm	B125	4B60.11.13	294.00



2.46.7	Strassenroste ACO	Nennweite	Raddruck (Klasse)	ACO-Modell	CHF/Stk
	auf Zementrohr mit Ausgleichsrahmen	600/700	B125	4B70.12.13	472.00
	in Zementrohrfalz	600	C250	3C60.11.13	519.00
	Federklemmrost mit Rahmen (zum Anpflastern)	37x52cm	C250	6C52.22.31	335.00



2.46.8	Gussabdeckung ACO zum auspflastern	Nennweite	Raddruck (Klasse)	ACO-Modell	CHF/Stk
	Rund, Innenhöhe 75 mm	Ø 60 cm	D400	2D6X.12.47	827.00
	Eckig, Innenhöhe 70 mm	60x60 cm	D400	2D6Q.12.47	1040.00
Zubehör:					
	Aushebeschlüsselset			77634	120.00

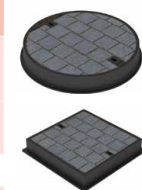

2.46.9	Aco Schachtabdeckungen	Artikel	Masse (AxA) mm	Masse (BxB) mm	Höhe mm	CHF.
	Paving z. auspflastern, Stahl feuerverzinkt	406572	600 x 600	736 x 736	120	1016.00
	Uniface Stahl verz., Tagwasser- und geruchdicht	415863	600 x 600	710 x 710	82,5	783.00
	Uniface Aluminium, Tagwasser- und geruchdicht	405340	300 x 300	398 x 398	72,5	639.00
		405343	500 x 500	598 x 598	72,5	799.00
		405345	600 x 600	698 x 698	72,5	829.00
	Edelstahl V2A, Tagwasser- und geruchdicht	415892	600 x 600	710 x 710	82,5	1797.00

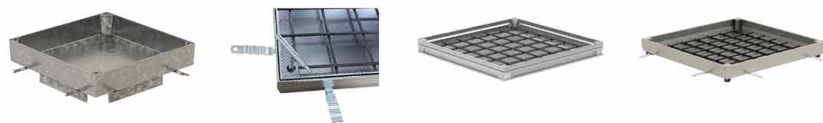

2.47 Lichtschächte

2.47.1 Lichtschächte bewehrt ⁺ (es sind auch andere Höhen und Schenkellängen lieferbar!)		Ausladung 60 cm		Ausladung 70 cm	
Breite in cm	Höhe cm	Gewicht kg	CHF/Stk	Gewicht kg	CHF/Stk
80	20	76	216.00	76	264.00
80	50	191	216.00		
80	75	286	252.00		
80	100	382	311.00	370	374.00
80	125	422	373.00	449	438.00
80	150	573	437.00	550	510.00
100	20	83	226.00	75	285.00
100	50	207	226.00		
100	75	310	293.00		
100	100	414	360.00	401	431.00
100	125	498	427.00	496	495.00
100	150	622	491.00	596	570.00
120	20	87	258.00	87	303.00
120	50	218	258.00		
120	75	327	327.00		
120	100	436	395.00	441	438.00
120	125	525	458.00	547	510.00
120	150	656	560.00	646	605.00
140	20	97	284.00	94	344.00
140	50	242	284.00		
140	75	326	351.00		
140	100	484	430.00	478	484.00
140	125	578	497.00	586	560.00
140	150	727	625.00	702	685.00
170	20	119	333.00	119	399.00
170	50	297	333.00		
170	100	593	476.00	595	550.00
170	125	691	575.00	744	645.00
170	150	890	735.00	893	790.00
190	20	142	367.00		
190	50	355	367.00		
190	100	710	530.00		
190	125	742	705.00		
190	150	1066	795.00		
210	20	162	405.00	176	405.00
210	50	398	481.00	423	479.00
210	100	805	685.00	845	685.00
210	150	1237	1010.00	1293	1020.00



2.47.2 Lichtschacht-Aufhängungen			CHF/Paar
Winkeleisen zum anschrauben klein			67.50
Winkeleisen verlängert für Aussenisolation Kombi A	bis 10 cm		114.00
Winkeleisen verlängert für Aussenisolation	6 bis 20 cm		163.00

2.47.3 Lichtschacht-Gitterroste			
Rostgrösse in mm	Maschen 30 x 30 mm CHF/Stk	Maschen 30 x 10 mm CHF/Stk	
830 x 610	73.00	105.00	
1030 x 610	84.00	122.00	
1230 x 610	101.00	145.00	
1430 x 610	140.00	191.00	
1730 x 610	169.00	-	
1930 x 610	189.00	-	



2.47.4 Gitterrostsicherungen			
	Grösse	zu Gitterrost	CHF/Paar
Sicherungshaken Typ B	18 cm	MW 20 bis 64 mm	47.50
Abus mit Schloss & Kette		ab MW 20 x 20 mm	73.75

2.48 Schachtleitern

Schachtleitern OSA, Aluminium			
einfache Montage der Konsolen mit Dübeln 12 mm			
Schachttiefe OK Deckel – OK Bankett in cm	Leiterlänge cm	Anzahl Sprossen	Preis inkl. Konsolen CHF/Stk
095 – 130	65	3	146.00
131 – 165	95	4	196.00
166 – 190	120	5	218.00
191 – 220	150	6	231.00
221 – 250	180	7	262.00
251 – 280	210	8	294.00
281 – 300	235	9	318.00
301 – 330	260	10	336.00
331 – 360	290	11	363.00
361 – 390	320	12	436.00
391 – 420	350	13	461.00
Einsteigehalterung hinten laufend	kurz		193.00
	lang		201.00



2.49 Entwässerungs-Rinnen ACO Drain Multiline V100

2.49.1 Rinnenkörper V 100 Länge 100 cm, Zarge Stahl verzinkt ohne Sohlgefälle

Typ	Höhe cm		Gewicht kg	Stk./Pal.	Art. Nr	CHF/Stk
	Anfang	Ende				
0.0	15,0	15,0	16,5	24	012330	115.00
5.0	17,5	17,5	19,0	24	012340	115.00
10.0	20,0	20,0	21,0	24	012350	115.00

mit Sohlgefälle 0,5%						
Typ	Anfang	Ende	Gewicht kg	Stk./Pal.	Art. Nr	CHF/Stk
1	15,0	15,5	16,5	24	012301	115.00
2	15,5	16,0	16,5	24	012302	115.00
3	16,0	16,5	17,0	24	012303	115.00
4	16,5	17,0	17,6	24	012304	115.00
5	17,0	17,5	18,0	24	012305	115.00
6	17,5	18,0	18,5	24	012306	115.00
7	18,0	18,5	19,0	24	012307	115.00
8	18,5	19,0	19,3	24	012308	115.00
9	19,0	19,5	19,7	24	012309	115.00
10	19,5	20,0	20,0	24	012310	115.00
11*	20,0	20,5	20,5	24	078351	115.00
12*	20,5	21,0	21,0	24	078352	115.00
13*	21,0	21,5	21,5	24	078353	115.00
14*	21,5	22,0	22,0	24	078354	115.00
15*	22,0	22,5	22,5	24	078355	115.00
16*	22,5	23,0	23,0	24	078356	115.00
17*	23,0	23,5	23,5	24	078357	115.00
18*	23,5	24,0	24,0	24	078358	115.00
19*	24,0	24,5	24,5	24	078359	115.00
20*	24,5	25,0	25,0	24	078360	112.00

* nur auf Bestellung

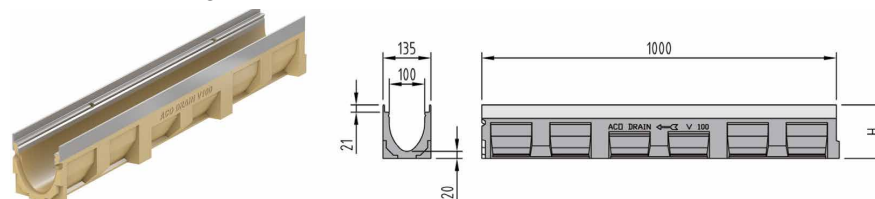

Wir haben über Mittag durchgehend geöffnet!



Von der Schönheit
der Natur inspiriert

ACO Design-Rost Voronoi



ACO Swissdrain mit Design-Rost Voronoi

Der Voronoi Gussrost für ACO Entwässerungssysteme ist inspiriert von der Schönheit der Natur. Durch die scheinbar zufällige Anordnung geometrischer Formen entsteht ein einzigartiges Design.

Das Muster findet sich wieder in den Flecken einer Giraffe, in Libellenflügeln, Blattadern oder den Rissen getrockneter Erde. Dank diesem organischen Motiv fügt sich der Rost gleichermaßen in eine mineralische und pflanzliche Umgebung ein.



2.49.2 Rinnenkörper V 100 Länge 100 cm Zarge Stahl verzinkt mit Lippenlabyrinthdichtung für senkrechten Anschluss DN 100

Typ	passend zu Typ	Höhe cm	Gewicht kg	Stk./Pal.	Art. Nr	CHF/Stk
0.0.2	0.0/0.1/1	16,0	16,7	24	012334	132.00
5.0.2	5.0/5.1/5/6	18,5	18,7	24	012344	132.00
10.0.2	10.0/10.1/10	21,0	20,1	24	012354	132.00

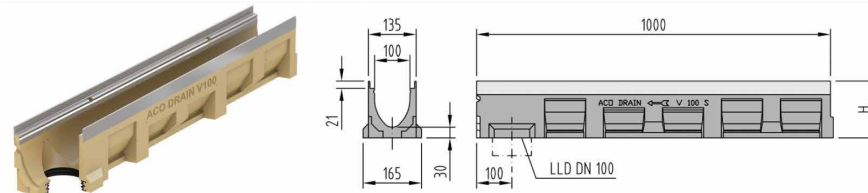

2.49.3 Rinnenkörper V 100 Länge 50 cm Zarge Stahl verzinkt mit Lippenlabyrinthdichtung für senkrechten Anschluss DN 100 und seitlichen Verformungen

Typ	passend zu Typ	Höhe cm	Gewicht kg	Stk./Pal.	Art. Nr	CHF/Stk
0.2	0.0/0.1/1	16,0	9,0	12	012333	117.00
5.2	5.0/5.1/5/6	18,5	9,4	12	012343	117.00
10.2	10.0/10.1/10	21,0	11,0	12	012353	117.00

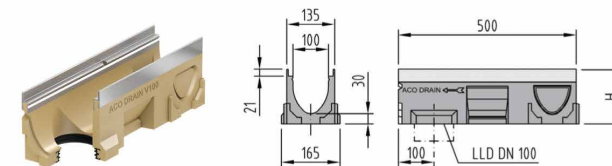

2.49.4 Rinnenkörper V 100 Länge 50 cm Zarge Stahl verzinkt mit senkrechter und seitlichen Verformungen DN 100

Typ	passend zu Typ	Höhe cm	Gewicht kg	Stk./Pal.	Art. Nr	CHF/Stk
0.1	0.0/0.2/0.0.2/1	15,0	9,1	12	012332	105.00
5.1	5.0/5.2/5.0.2/5/6	17,5	9,7	12	012342	105.00
10.1	10.0/10.2/10.0.2	20,0	11,3	12	012352	105.00

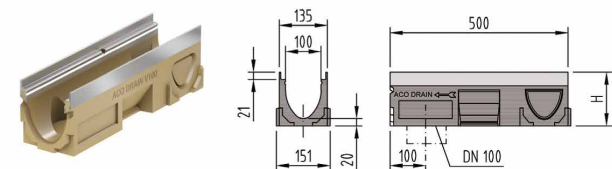

2.49.5 Flachrinne V 100 Länge 100 cm Zarge Stahl verzinkt

Typ	Höhe cm	Gewicht kg	Stk./Pal.	Art. Nr	CHF/Stk
FL 6 cm	6,0	8,2	30	012325	115.00
FL 8 cm	8,0	11,5	30	012323	115.00
FL 10 cm	10,0	13,0	30	012321	115.00

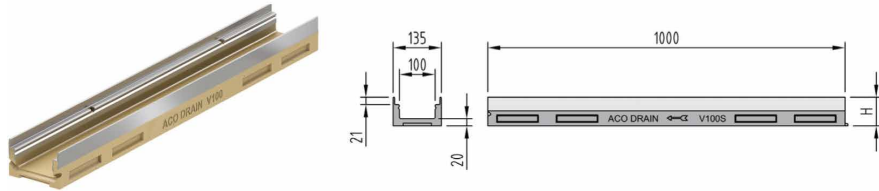

2.49.6 Flachrinne V 100 für senkrechten Ablauf

Länge 100 cm mit eingegossenem senkrechtem PE-Stutzen DN 100, Zarge Stahl verzinkt

Typ	Höhe cm	Gewicht kg	Stk./Pal.	Art. Nr	CHF/Stk
FL 6 cm	6,0	8,2	30	012326	132.00

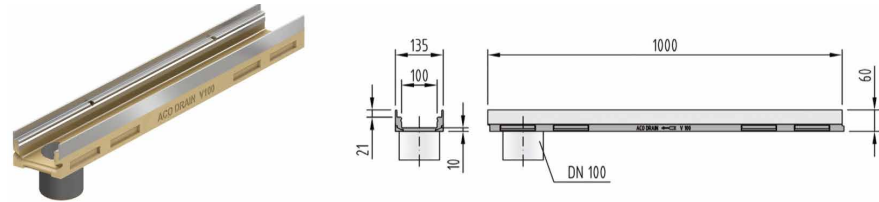

2.49.7 Flachrinne V 100 für senkrechten Ablauf

Länge 100 cm mit Lippenlabyrinthdichtung für senkrechten Ablauf DN 100, Zarge Stahl verzinkt

Typ	Höhe cm	Gewicht kg	Stk./Pal.	Art. Nr	CHF/Stk
FL 8 cm	9,0	14,5	30	012324	132.00
FL 10 cm	11,0	15,5	30	012322	132.00

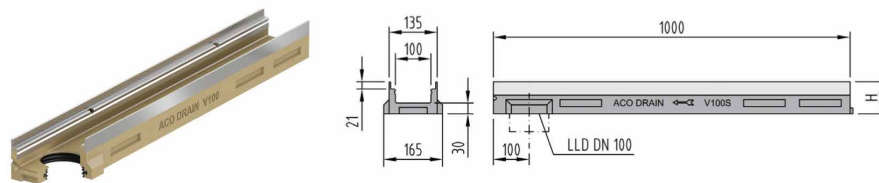

2.49.8 Einlaufkasten V 100 mit Schlammweimer

Länge 50 cm mit Lippenlabyrinthdichtung, Kurzform, Zarge Stahl verzinkt

passend zu Typ	für Anschluss	Höhe cm	Gewicht kg	Stk./Pal.	Art. Nr	CHF/Stk
0.0 – 10	DN 100	45,0	24,5	10	012391	273.00

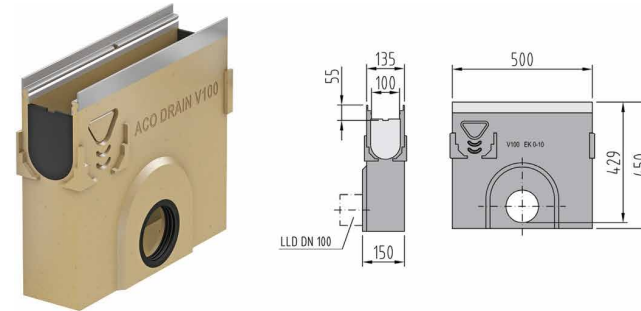

2.49.9 Zubehör für Multiline V 100







Stirnwände, Zarge Stahl verzinkt

	für Typ	kg	Art. Nr	CHF/Stk	
	0 bis 20	1,4	012385	35.00	
		0	1,2	012386	55.00
		5	1,4	012387	55.00
		10	1,6	012388	55.00
	15	1,8	012389	55.00	
	6 cm	0,6	012382	36.00	
	8 cm	0,6	012381	36.00	
	10 cm	0,7	012380	36.00	
	6 cm	0,2	012376	42.00	
	8 cm	0,3	012384	42.00	
	10 cm	0,3	012338	42.00	

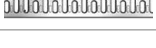
2.49.10 Rohrstützen für Rinnenkörper bzw. Einlaufkasten (solange Vorrat)

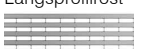
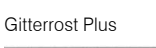
	Länge cm	Art. Nr	CHF/Stk
	10,0	001014	26.00
	18,0	001015	38.00

2.49.11 Abdeckroste Drainlock für Multiline V 100

	Belastungs- klassen	Material	Mass	Länge cm	kg	Stk/ Pal	Art. Nr	CHF/Stk
Stegrost 	A	Stahl verzinkt	Schlitzweite 10mm	100,0	2,2	200	012610	51.00
	A			50,0	1,0	200	012611	46.00
Doppelstegrost 	C	Stahl verzinkt	Schlitzweite 10mm	100,0	4,3	200	012614	102.00
	C			50,0	2,2	200	012615	77.00
Lochrost 	A	Stahl verzinkt	ø 6 mm	100,0	3,0	200	012666	144.00
	A			50,0	1,6	200	012667	97.00
	A	Edelstahl	ø 6 mm	100,0	2,4	100	012664	180.00
	A			50,0	1,2	100	012665	118.00
Längsprofilrost 	B	Stahl verzinkt		100,0	3,9	100	132555	123.00
	B			50,0	1,9	100	132550	89.00
	B	Edelstahl		100,0	3,9	100	132556	281.00
Gitterrost Plus 	B	Stahl verzinkt	Maschenweite 30 x 10 mm	100,0	3,2	100	132560	88.00
	B			50,0	1,6	100	132561	68.00
	C	Edelstahl	Maschenweite 30 x 10 mm	100,0	2,8	200	132880	112.00
	C			50,0	3,3	200	132881	85.00
	D	Edelstahl	Maschenweite 30 x 10 mm	100,0	3,1	200	132885	142.00
	D			50,0	1,5	100	132886	105.00
Kunststoffrost schwarz 	B	Kunststoff	Schlitzweite 8 mm	50,0	0,8	204	132710	60.00
	C			50,0	1,0	204	132720	67.00
Gussrost Heelguard GGG 	C	Gusseisen GGG KTL	Schlitzweite 5 mm	50,0	3,8	200	46540	85.00
Gussrost GGG 	C	Gusseisen GGG	Schlitzweite 12 mm	50,0	3,3	200	012670	65.00
	D			50,0	4,0	200	012671	76.00
	C	Gusseisen GGG KTL		50,0	3,3	200	049330	73.00
	D			50,0	4,0	200	049506	83.00
Zubehör für Abdeckroste							100699	30.00
Rosthacken zum Ausheben der Roste 								

2.49.12 Schlitzaufsatzelement aus Edelstahl V2A, Schlitzbreite 1,8 cm

	Klasse	Länge cm	Breite cm	Höhe cm	Einlauf cm ² /m	Art. Nr	CHF/Stk
zentrisch 	C 250	100,0	12,3	8,0	180	100520	295.00
			12,3	8,0	180	100523	216.00
		50,0	12,3	10,0	180	100521	302.00
			12,3	10,0	180	100524	223.00
		100,0	12,3	12,0	180	100522	319.00
			12,3	12,0	180	100525	234.00
exzentrisch 	C 250	100,0	12,3	8,0	180	100551	372.00
			12,3	8,0	180	100611	272.00
		50,0	12,3	10,0	180	100552	382.00
			12,3	10,0	180	100612	280.00
		100,0	12,3	12,0	180	100553	408.00
			12,3	12,0	180	100613	291.00

Zubehör für Schlitzaufsatzelement aus Edelstahl V2A

	Material	Länge cm	Höhe cm	Art. Nr.	CHF/Stk
Stirnwand steckbar	Edelstahl		8,0	100530	41.00
			10,0	100531	41.00
			12,0	100532	41.00
Schlitzrost	Edelstahl	100,0	15,0	200791	99.00
		50,0	15,0	200793	80.00

2.49.13 Serviceelement zu Schlitzaufsatzelement aus Edelstahl V2A

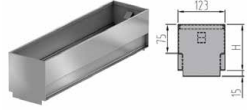
	Klasse	Länge cm	Breite cm	Höhe cm	Einlauf cm ² /m	Art. Nr	CHF/Stk
	C 250	50,0	12,3	8,0	190	100614	414.00
			12,3	10,0	190	100615	425.00
			12,3	12,0	190	100616	434.00

Zubehör für Serviceelement aus Edelstahl V2A

	Belastungs- klassen	Material	Mass	Länge cm	Breite cm	Höhe cm	Art. Nr	CHF/Stk
Einsatz für wählbare Oberfläche	D	Edel- stahl	zentrisch	aussen 46,0 innen 44,7	aussen 8,0 innen 7,0	7,5	100617	306.00
			exzentrisch				100128	306.00
Lochrost begehbar	A		Lochweite 8mm	50,0	11,0	7,5	100618	118.00
Längsschlitz- rost begehbar	A		versetzt 25/5 10mm	50,0	11,0	7,5	100619	118.00
Schlitzrost befahrbar	D		Schlitzweite 30/8 + 40/8	50,0	11,0	7,5	100620	329.00

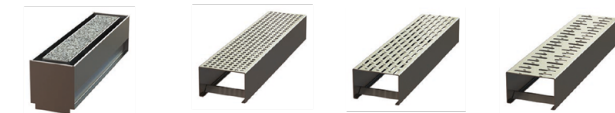

2.50 Schwerlast-Rinnen ACO Drain Multiline S 100 K, Klasse D 400

2.50.1 Rinne S 100 K Länge 100 cm, mit Verformung für senkrechten Ablauf, komplett inkl. Gussrost					
Typ	Höhe cm	Gewicht kg	Stk./Pal.	Art. Nr	CHF/Stk
0,0, ohne Gefälle	16,5	35	20	78340	155.00

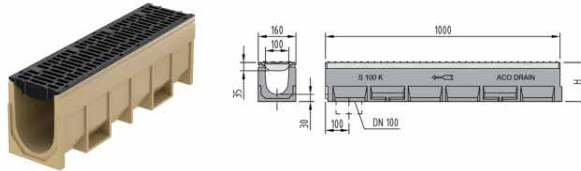

S 100 K Kombi-Stirnwand mit Gusskante für Typ 0,0 **30.50**

2.51 Entwässerungs-Rinnen ACO Drain Multiline V150

2.51.1 Rinnenkörper V 150 Länge 100 cm, Zarge Stahl verzinkt, ohne Sohlengefälle						
Typ	Höhe cm		Gewicht kg	Stk./Pal.	Art. Nr	CHF/Stk
	Anfang	Ende				
0,0	21,0	21,0	27,8	12	012730	185.00

mit Sohlengefälle 0,5% auf Bestellung

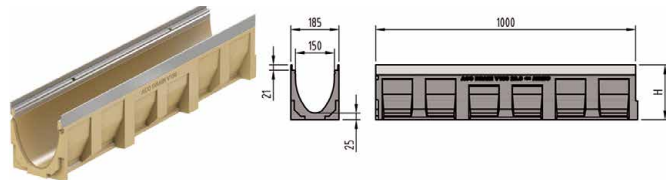

2.51.2 Rinnenkörper V 150 für senkrechten/seitlichen Anschluss

Länge 50 cm, Zarge Stahl verzinkt, mit Lippenlabyrinthdichtung für senkrechten Anschluss DN 150

Typ	Passend zu Typ	Höhe cm	Gewicht kg	Stk./Pal.	Art. Nr	CHF/Stk
0,0.2	0,0 / 0,1 / 1	22,0	31,2	8	012731	208.00

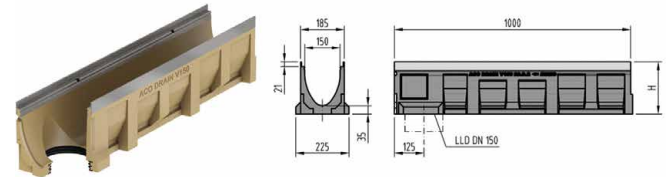

2.51.3 Einlaufkasten V 150 mit Schlammweimer

Länge 50 cm mit Lippenlabyrinthdichtung, Zarge Stahl verzinkt

passend zu Typ	für Anschluss	Höhe cm	Gewicht kg	Stk./Pal.	Art. Nr	CHF/Stk
0,0 - 20	DN 150	61,0	36,4	8	012791	603.00

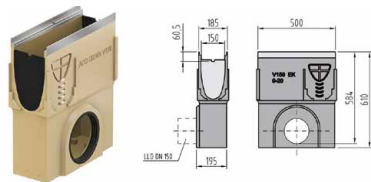

2.51.4 Abdeckroste Drainlock für Multiline V 150

	Belastungs-klassen	Material	Mass	Länge cm	kg	Stk./Pal	Art. Nr	CHF/Stk
Gitterrost Plus	B 136	Stahl verzinkt	Maschenweite 30 x 10 mm	100,0	5,5	100	133601	139.00
	B 101			50,0	2,7	48	133602	104.00
Gitterrost Q+	D 241	Maschenweite 28x9 mm	100,0	8,0	100	133609	246.00	
	D 173			50,0	3,9	48	133610	177.00
Gussrost	C	Gusseisen GGG KTL	Schlitzweite 12 mm	50,0	6,0	96	76542	98.00
	E			50,0	7,8	96	49321	117.00

2.51.5 Soba Rinnen NW 80 CrNi-Stahl

	L x B x H mm	CHF/Stk
Rinne, beidseitig gelocht, 1,0 mm	2000x80x40	63.00
Stirnwand	2000x80x60	63.00
80x40		5.60
Schlitzrost eckig MW, 25/8 mm	2000x74x18	32.20
Schlitzrost gerundet Ø12 mm	2000x74x18	32.20
Schlitzrost oval, 26/6 mm	2000x74x18	32.20



Soba Rinnen NW 125 Edelstahl

Rinne, beidseitig gelocht, 1,0 mm stark	2000x125x40	74.20
Stirnwand	125x40	5.60
Lochrost Ø12 mm, 1,5 mm stark	2000x122x20	63.00
Schlitzrost eckig MW, 25/8 mm	2000x122x20	63.00



2.51.6 Drainrinnen begehbar Volfi



	Masse	VE	Art. Nr.	CHF/Stk
DR-ASL, Alu Drain-Rost, Schlitzloch 25/3 Länge: 2,0 m	42 / 15 mm	1	117 801	86.90
	92 / 15 mm	1	117 802	99.00
	142 / 35 mm	1	117 808	143.00
KR-SL, Alu-Kastenrinne gelocht, mit Schlitz Länge: 2,0 m	100x17mm	1	117 812	101.00
	150x37mm	1	177 818	155.00
KR-OL, Alu-Kastenrinne ungelochte Bodenseite Länge: 2,0 m	50x17mm	1	117 821	96.00
	100x17mm	1	117 822	101.00
	150x37mm	1	117 828	155.00
Verbinder für KR-SL / KR-OL, Alu	50 x 17mm	1	117 838	9.00
	100 x 17mm	1	117 848	10.20
	150 x 37mm	1	117 858	11.20
Abschlussplatte für KR-SL / KR-OL, Alu	50 x 17mm	1	117 839	13.50
	100 x 17mm	1	117 849	14.50
	150 x 37mm	1	117 859	17.00



2.51.7 Drainprofile Volfi

	Masse	VE	Art. Nr.	CHF/Stk
WD-C, Drainprofil Alu 2mm C-Form, Länge: 2,0 m	25 x 17mm	1	117 522	55.00
	20 x 37mm	1	117 514	77.00
WD-Z Drainprofil mit Belaganbindung, Alu 2mm, Z-Form, Länge: 2,0 m	B x H x Auflage 45 x 47 x 140	1	117 556	140.00
	25 x 27 x 140	1	117 543	110.00
Steckverbinder für WD-C oder WD-Z Alu	100/30mm breit	1	117 598	9.00

alle Preise exkl. MwSt

Soba Fugenprofile (Terrazza)	Masse LxBxH		CHF/m
Edelstahl, 0,8 mm	2000x18x20mm		14.00
	2000x18x30mm		15.40
	2000x18x40mm		16.80
Disto Profile 	Masse LxB	Höhe	CHF/m
Distanzprofil für Fassadenanschluss, Hart-PVC, UV-beständig, Hellgrau	2000x12mm	19 mm	5.90
		28 mm	6.00
		38 mm	6.10
		57 mm	6.40
		77 mm	6.60
Winkelprofile	Masse LxB	Höhe	CHF/m
Edelstahl 0.8 mm neu Kantungen: 12-20-Höhe-25	2000x20mm	20 mm	15.80
		30 mm	15.80
		40 mm	15.80
		60 mm	17.80
		Ringo Kiesring 	
Rückhaltung Dachkies neu	Ø 356 mm	80 mm	11.50



2.51.8

Volfi Drain Schächte/ Abläufe	Masse	VE	Art. Nr.	CHF/Stk
DP-AF,-Drainplatte, 3mm dick, Alu	DP-AF2, 191x191x14mm	1	117 930	43.00
	DP-AF3 284x284x20mm	1	117 940	54.00
DP-GU,-Draingully, Unterteil DP-AF, Alu	für DP-AF2, 200x200x17mm	1	117 932	43.00
	für DP-AF3 H: 23mm	1	117 942	54.00
DP-FS, Kontrollschacht, 300x300 mm aussen, 285/285 innen	Höhe 300mm	1	117 944	54.00
GU-AV Alu-Draingully komplett 2 mm stark	200x200 mm, 30-50 mm	1	117 672	133.50
	200x200 mm, 60-95 mm	1	117 674	133.50
	400x400 mm, 30-50 mm	1	117 682	269.00
	400x400 mm, 60-95mm	1	117 684	269.00

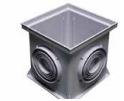
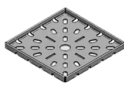

Soba Ablaufschächte Edelstahl 1,0 mm neu		CHF/Stk
Ablaufschacht komplett	150x150x40mm	50.40
Schlitzrost gerundet 25/8mm (eckig auf Bestellung)	200x200x40mm	60.20
	200x200x60mm	63.00
	200x200x90mm	65.80
	Soba Kiesrahmen	200x200x40mm
Grundrahmen	200x200x60mm	23.80
	200x200x90mm	26.80
Soba Aufsatzrahmen	200x200 mm	21.00
	Edelstahl 1,0mm	



distanzprofil für fassadenanschluss

disto®

h19 mm | h28 mm | h38 mm | h57 mm | h77 mm
hellgrau | lichtgrau | caramel

dezentestes Profil in 3 Farben verfügbar!

 plastic in form

CH-5724 Dürrenäsch | +41 62 767 50 20 | info@profilisager.ch | profilisager.com

Bodenablauf	Masse	VE	Art. Nr.	CHF/Stk
BA, Uni-Bodenablauf, Kunststoff	200/200mm, Höhe 135mm	6	109 640	35.20



2.51.9

ACO Schächte				
Hofablauf mit Gussrost Klasse C 250 H: 440 mm	430 x 430 mm	1	77665	365.00
Aufsatzkasten zur Aufstoc-ckung um 250mm	285 x 285 mm	1	2716	89.00
Ausgleichselement 60mm	285 x 285 mm	1	2717	48.00
ACO Passino DN 100 DN 125 ohne Klebeflansch, mit Geruchsverschluss	104 x 104 mm	1	2310.87.00	105.00
	104 x 104 mm		2325.87.00	108.00



2.52 Kanalisationsrohre

2.52.1 Kanalisationsrohre aus Hart-PVC/HPE/PP alle Preise inkl. Dichtung

Nennweite in mm	PP SN 4 600 cm *CHF/m ¹	PP (beige) SN 8 600 cm *CHF/m ¹	HPE (schwarz) SN 4 600 cm *CHF/m ¹	* PVC 200 cm CHF/m ¹	* PVC 500 cm CHF/m ¹
110	5.10	5.70	6.10	*8.80	*8.00
125	6.65	7.25	7.90		
160	10.65	11.85	13.00		
200	17.30	19.20	19.90		
250		30.00	32.40		*38.00
315		48.70			*62.00

* solange Vorrat



2.52.2 Sickerrohre aus Hart-PVC/HPE/PP, gelocht Preis exkl. Dichtungen

Nennweite in mm	PP SN 4	PP SN 8	HPE SN 4
	CHF	(beige) 6m CHF	(schwarz) 6m CHF
110	5.35/m ¹	6.00/m ¹	6.30/m ¹
125	7.00/m ¹	7.65/m ¹	8.20/m ¹
160			13.60/m ¹

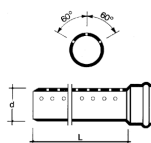

streng
Pipes for Generations



Kunststoffrohr-Systeme

Ob Kanal, Kabelschutz oder Druck, mit den Streng Kunststoffrohren und -Formteilen erhalten Sie die passende Lösung für Ihr Projekt. Neu mit Solarstrom produziert.

Pipes for Generations

www.streng.swiss

2.52.3 Kanalrohrbogen aus PP (beige) SN 8

Nennweite mm	15 Grad CHF/Stk.	30 Grad CHF/Stk.	45 Grad CHF/Stk.	88,5 Grad CHF/Stk.
110	3.80	3.80	3.80	4.70
125	5.10	5.10	5.10	5.90
160	8.50	8.50	8.50	10.70
200	19.00	19.00	19.00	26.00
250	48.00	48.00	48.00	52.00
315	86.00	86.00	86.00	93.00

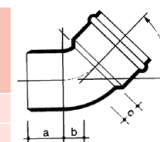

2.52.4 Kanalrohrbogen aus HPE (Kurzbogen) schwarz, gespritzt

Nennweite mm	15 Grad CHF/Stk.	30 Grad CHF/Stk.	45 Grad CHF/Stk.	88,5 Grad CHF/Stk.
110	13.00	13.00	13.00	15.00
125	15.00	15.00	15.00	17.00
160	24.00	24.00	24.00	28.00
200	35.00	35.00	35.00	46.00
250	126.20	129.90	171.40	228.50

Preise inkl. Dichtung

2.52.5 Tauchbogen 90° aus Hart-PVC / HPE mit Handgriff

Nennweite in mm	HPE schwarz CHF/Stk.	PVC orange CHF/Stk.
110	30.00	46.00
125	40.00	52.00
160	55.00	71.00
200	110.00	110.00

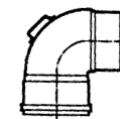

2.52.6 Abzweiger und T-Stücke aus HPE/PP

Nennweite in mm	PP beige Abzweiger CHF/Stk.	HPE schwarz Abzweiger, gespritzt CHF/Stk.
110/110	7.10	19.00
125/110	9.50	25.00
125/125	10.20	25.00
160/110	21.00	41.00
160/125	21.50	41.00
160/160	22.00	41.00
200/110	38.00	65.00
200/125	38.00	65.00
200/160	38.00	65.00
200/200	41.00	65.00

auch grössere Nennweiten an Lager

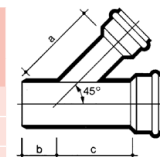

2.52.7 Reduktionen aus Hart-PVC/HPE/PP

Nennweite in mm	PP beige CHF/Stk.	HPE schwarz gespritzt CHF/Stk.
125/110	7.50	15.00
160/110	11.00	23.00
160/125	11.00	23.00
200/125	17.00	30.00
200/160	17.00	30.00

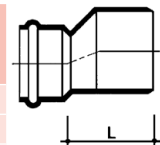

alle Preise exkl. MwSt

2.52.8 Überschiebemuffen aus Hart-PVC/HPE/PP Doppelsteckmuffen

Preise per Stück inkl. Dichtungen

Nennweite in mm	PP beige CHF/Stk.	HPE schwarz gespritzt CHF/Stk.
110	3.20	13.90
125	4.50	17.05
160	7.80	27.50
200	15.00	52.70
250	40.00	-
315	65.00	-

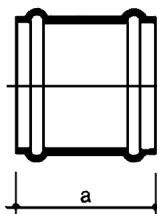

2.52.9 Schachtfutter inkl. Dichtung

Nennweite in mm	Eternit CHF/Stk.	Aco Polymerbeton CHF/Stk.
110		17.00
125		18.00
160		19.00
200		27.00
250	43.00	
315	56.00	

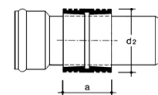

2.52.10 Abschlussdichtung M.O.L. auf Betonhauptrohre und -schächte

für Nennweite in mm	Bohrloch Ø	Art. Nr.	CHF/Stk.
100	138 mm +/- 1	TMOL 1160	10.00
125	151 mm +/- 1	TMOL 1170	12.00
150	186 mm +/- 1	TMOL 1180	13.00*
200	226 mm +/- 1	TMOL 1190	16.00*

* nur auf Bestellung



2.52.11 Deckel zu Kanalrohren

Nennweite in mm	PP Muffendeckel CHF/Stk.
110	2.70
125	3.20
160	4.50
200	8.70
250	22.90
315	32.00

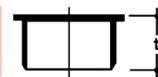

2.52.12 Übergangsstücke für Kanalsation

		CHF/Stk.
Flex-Übergang PP/PVC/PE - BR	DN 100 mm	50.00
	DN 125 mm	58.00
	DN 150 mm	80.00
Flex-Übergang PP/PVC/PE - STZ	DN 100 mm	35.00
	DN 125 mm	50.00
	DN 150 mm	70.00



alle Preise exkl. MwSt

Chromstahlbriden 3-teilig Mod. CH	für Stzg D 100 mm	120.00
	für Stzg D 125 mm	138.00
	für Stzg D 150 mm	144.00
	für Stzg D 200 mm *	166.00
	für Stzg D 250 mm *	181.00
* bis D 500mm auf Bestellung		359.00



HDPE-Übergänge auf Steinzeug ohne Muffe	110 mm	124.00
	125 mm	133.00
	160 mm	172.00



Gummi-Ue-Ring HDPE-Steinzeug (im Kanton BS nicht zulässig)	110 mm	44.00
	125 mm	53.00
	160 mm	54.20



2.52.13 Gleitmittel zu PVC-Rohren

Flasche 0,5 kg	CHF/Stk.	6.60
----------------	----------	------

2.52.14 Drainflex – Drainagerohre, gewellt, teilgeschlitzt, Graiflex, Rollen zu 50 m, aus PE, schwarz

Nennweite in mm	ganze Rollen CHF/m'	Offenverkauf CHF/m'
50	1.50	2.10
65	1.80	2.50
80	2.40	3.10
100	3.50	4.20
125	6.40	-
160 (nur auf Bestellung)	9.35	-

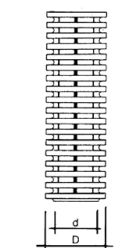

2.52.15 Formstücke zu Drainflex-Drainagerohren Eurodrain

passend zu Nennweite mm	Endkappen CHF/Stk.	Doppelsteckmuffe CHF/Stk.	Abzweiger 45° CHF/Stk.	T-Stücke 90° CHF/Stk.
50	1.25	1.80	14.90	13.00
65	1.80	3.10	17.50	14.80
80	2.90	4.20	23.00	20.00
100	3.80	5.80	27.00	24.00
125	4.60	7.80	38.00	32.00

2.52.16 Putzdeckel aus Guss für Kunststoffrohre mit Bajonettverschluss

DN 100	CHF/Stk.	141.00
DN 125	157.00	
DN 150	172.00	



2.52.17 Spülstutzen mit Bajonettverschluss

Nennweite in mm	PP CHF/Stk.	Alu CHF/Stk.	HPE CHF/Stk.
110	30.00	63.00	48.40
125	35.00	66.00	52.30
160		97.00	68.70



2.53 Kabelschutzrohre, Elektro-Leerrohre

2.53.1	Elektrorohre gerippt, aus Polyäthylen PP-Flex	Farbe	Rollenlänge m	offen CHF/m ¹	ganze Rolle CHF/m ¹
	KRF M 20	orange	100	1.40	0.90
	KRF M 25	blau	100	1.70	1.20
	KRF M 32	blau	50		1.50
	KRFWG M 40	blau	50		2.90
	KRFWG M 63	blau	25		7.80



2.53.2	Elektrorohre PE, doppelwandig	Farbe	Rollenlänge m	ganze Rolle CHF/m ¹
	Kabuflex R 40/33mm	schwarz	50	2.60
	Kabuflex R 50/40mm			3.00
	Kabuflex R 63/52mm			3.20
	Kabuflex R 75/63mm			3.50
	Kabuflex R 90/75mm			4.20
	Kabuflex R 110/90mm			5.20



2.53.3	Kabelschutzrohre mit Muffe, aus PEHD (+ Teuerungszuschlag)	Nennweite in mm	Länge m	CHF/m ¹
		K55	5	4.35
		72/60	5	5.65
		92/80	5	7.40
		112/100	5	9.15
		132/120	5	10.90

2.53.4	Kabelschutzrohr-Formstücke		CHF/Stk
	Kabelschutzrohr-Bogen K55 63mm	R= 600mm	49.30
	Kabelschutzrohr-Bogen 45° 72/60mm	R= 600 mm	27.60
	Kabelschutzrohr-Bogen 45° 92/80mm	R= 800 mm	34.80
	Kabelschutzrohr-Bogen 45° 112/100mm	R= 1000 mm	51.90
	Kabelschutzrohr-Bogen 45° 132/120mm	R= 1200 mm	54.90
	Kabelschutzrohr-Bogen 90° 72/60mm	R= 600 mm	35.00
	Kabelschutzrohr-Bogen 90° 92/80mm	R= 800 mm	43.90
	Kabelschutzrohr-Bogen 90° 112/100mm	R= 1000 mm	62.80
	Kabelschutzrohr-Bogen 90° 132/120mm		72.90
	Kabelschutzrohr-Flexbogen -45° 92/80mm	(kurze Ausführung)	32.90
	Kabelschutzrohr-Flexbogen 45-90° 72/60mm		39.10
	Kabelschutzrohr-Flexbogen 45-90° 92/80mm		48.10
	Kabelschutzrohr-Flexbogen 45-90° 112/100mm		71.90
	Kabelschutzrohr-Flexbogen 45-90° 132/120mm		74.40
	Kabelschutzrohr-Doppelmuffe K55	inkl. Dichtungen	8.30
	Kabelschutzrohr-Doppelmuffe 72/60 mm	inkl. Dichtungen	6.70
	Kabelschutzrohr-Doppelmuffe 92/80 mm	inkl. Dichtungen	7.50
	Kabelschutzrohr-Doppelmuffe 112/100 mm	inkl. Dichtungen	9.10
	Kabelschutzrohr-Doppelmuffe 132/120mm	inkl. Dichtungen	11.20

2.54 Geotextilien, Filtervliese, Filtergewebe

2.54.1	Trenn- und Filtervlies GEO 150	Gewicht g/m ²	Rollenbreiten	Rollenlänge	offen ab Rolle CHF/m ²	ganze Rollen CHF/m ²
	GEO 150 weiss	150	1 m	100 m		1.25
	GEO 150 weiss	150	2 / 3 m	100 m	(nur 2m) 2.30	1.19

2.54.2	Sytec Produkte	Breite cm	Länge/Rolle	ganze Rollen CHF/m ²
	Sytec - Geovlies NW light, 150 g/m ² , 8 kN /m ¹	200/265/400	100 m	0.90
	Sytec - Geovlies NW uni, 160 g/m ² , 10 kN /m ¹	200/400	100 m	1.10

2.54.3	FLN Schutz- und Trennvlies	Gewicht g/m ²	Breiten m	Rollenlänge m	ganze Rollen CHF/m ²
	ACM 800	800	2,5 / 5	50	5.52
	Ecoroof ECR300 (Teichvlies)	300	2	100	2.67

2.54.4	Filtergewebe	Breite cm	Länge/Rolle	ganze Rollen CHF/m ²
	Landogeo Filter	260	100 m	2.70
	Sytec - Geofiltergewebe HF 400 fein	130 / 265	100 m	2.60
	Sytec - Geofiltergewebe HF 1300 grob	265	100 m	2.40

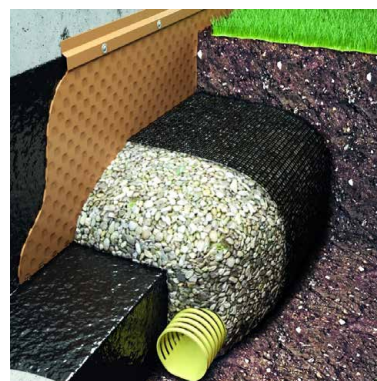

Landogeo Filter

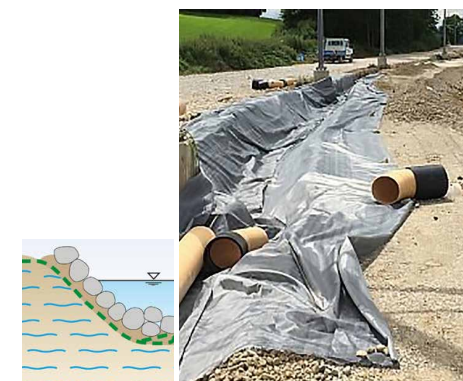

Sytec HF

2.54.5	Biovlies	Gewicht g/m ²	Breite m	Rollenlänge m	ganze Rollen CHF/m ²
	Green NW, mind. 5 Jahre UV-beständig	180	2	25	4.80

2.54.6	PP Vlies, grau, UV-stabilisiert, grau, (Dachvlies) SK-1000-UV auch als Unkrautemmlies geeignet	Rollengrösse m	offen ab Rolle	ganze Rollen CHF/m ²
	ca. 125 g/m ²	2,25 x 100	2.30	1.50

LANDOLT™

Der Schweizer Spezialist für temporären Oberflächenschutz

Multifunktionaler Bauteilschutz

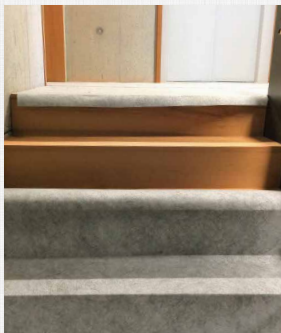

Familie ALLPROTECT by Landolt.com™

Multifunktionaler Flächenschutz



Floorliner™ Familie mit Logodruck

Geokunststoffe



GEO 150



Floorliner™ Familie



WERBEWIRKSAMER FLÄCHENSCHUTZ

- ✓ Für jede Anwendung den richtigen Floorliner™.
- ✓ Vierfarben-Logoaufdruck zur Kommunikation Ihrer Markenwerte. Für einen starken Auftritt mit bleibender Erinnerung.
- ✓ Ab 1 Palette und ohne Mehrkosten bei Druck in 10cm Höhe und mit einer Wiederholung von 3m. Andere Dimensionen auf Anfrage.

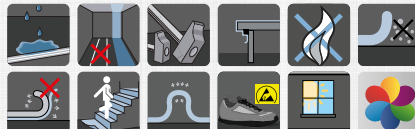

ALLPROTECT Familie



MULTIFUNKTIONALER BAUTEILSCHUTZ

- Original:** Robustes Schutzvlies, das höchsten Ansprüchen gegenüber mechanischem Schutz gerecht wird.
- FR*:** Schutzvlies für besondere Ansprüche hinsichtlich Brennbarkeit und Antistatik.
- Flex:** Vielseitig einsetzbares Schutzvlies mit besonderem Augenmerk auf Flexibilität bei gewohnter Klebewirkung.
- White:** Lichtdurchlässiges selbstklebendes Schutzvlies für vertikale Flächen – Idealer Schutz für Glasflächen.



«WIR SCHÜTZEN, WAS IHNEN WICHTIG IST»

FRITZ LANDOLT AG

Bahnhofstrasse 35 | CH-8752 Näfels | SWITZERLAND
Tel +41 (0)55 618 51 00 | info@landolt.com | www.landolt.com

alle Preise exkl. MwSt

2.54.7 Unkrautemmvlies Weedguard	Gewicht g/m ²	Rollen-grösse m	ganze Rollen CHF/m ²
anthrazit	90	2,25 x 50	1.75



2.54.8 Wurzelschutzvlies «Root Guard» 1,2 mm stark (ca. 260 g/m ²) wasserdurchlässig	Breite cm	Länge m/Rolle	ganze Rollen CHF/m ²
Root Guard	225	25	4.25



2.54.9 Plantex Gold, Mulchvlies 125 g/m ² UV-beständig	Rollengrösse m	ganze Rollen CHF/m ²
ca. 125 g/m ²	2 x 100	3.40



2.54.10 Bändchengewebe	Gewicht g/m ²	Breite m	Rollenlänge m	ganze Rollen CHF/m ²
Landogeo PP 15/15	100	2,6/5,2	100	1.18
Biogewebe Duracover UV-beständig	ca. 120	2,5	100	4.00



2.54.11 Wurzelsperre ReRoot 2000 (Rhizomsperre/Bambussperre)	Breite cm	Länge m/Rolle	offen	ganze Rollen
HDPE schwarz, 2 mm stark	70	25	14.80/m	11.50/m
	100	25	19.80/m	16.50/m
	150	50		19.80/m
	200	50		24.00/m

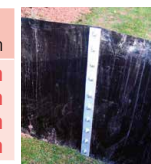

Alu-Rhizomsperrenverschluss	70 100		33.00/Stk 42.00/Stk	
U-Rhizomsperrenverschluss verzinkt	70 100		69.00/Stk 89.00/Stk	
ReRoot Klebeband		10		59.50/Rolle



nur auf Bestellung

2.55

Böschungsmatten	Grösse in m	Einheit	CHF/m ²
Soil Savers (Erosionsschutz aus Jute)	ca. 500g/m ²	1,22 x 50 m	61m ² 2.40
Kokosgewebe	ca. 400g/m ²	2 x 50 m	100m ² 2.90
	ca. 700g/m ²	2 x 50 m	100m ² 3.90



DELTA®-TERRAXX FAMILIE

DAUERHAFT DRAINIEREND. HOCH BELASTBAR. LANGLEBIG.





DELTA®-TERRAXX
Universelles Schutz- und Drainagesystem.

DELTA®-TERRAXX LIGHT
Normale Belastungen unter begrüntem und begehbaren Flächen.

 Verlegbar unter Flächen mit extensiver oder intensiver Begrünung.

 Verlegbar unter begehbaren Flächen.

 Verlegbar unter PKW-befahrenen Flächen.

 Für vertikale Anwendungen im Tief- und Ingenieurbau mit bis 10 m Einbautiefe.

 Verlegbar unter Flächen mit extensiver oder halbintensiver Begrünung.

 Verlegbar unter begehbaren Flächen mit Plattenbelägen im Splittbett oder Pflasterbelägen im Sandbett.

 Für vertikale Anwendungen mit bis 3 m Einbautiefe.



Jetzt mehr erfahren!

3.1 Bitumen-Dichtungsbahnen

3.1.1 Swisspor BIKUTOP LL (Long Life)

Dampfbremsen	Oberfläche oben/unten	Dicke mm	Breite m'	Länge m'	m ² /Pal.	CHF/m ²
BIKUPLAN LL VARIO v	Vlies/Gleitlage, 10 cm Folie	3,5	1,10	8	176,0	12.00
BIKUPLAN LL VARIO Stria	Vlies/Gleitlage, 10 cm Folie	3,5	1,10	8	176,0	11.90
BIKUVAP LL EVA flam	ts/flam	3,5	1,10	8	193,6	7.90



Unterbahnen						
BIKUPLAN LL VARIO v	Vlies/Gleitlage, 10 cm Folie	3,5	1,10	8	176,0	12.00
BIKUPLAN LL VARIO Stria	Vlies/Gleitlage, 10 cm Folie	3,5	1,10	8	176,0	11.90

Oberbahnen (Gefälle ≥ 1.5 %)						
BIKUTOP LL SPEED *	Schiefer hellgrau/flam	4,2	1,10	8	176,0	12.30
BIKUTOP LL SPEED WF *	Schiefer hellgrau/flam	4,2	1,10	8	176,0	12.70
BIKUTOP LL TERRA *	Schiefer grau/flam	5,2	1,10	7	115,5	13.20
BIKUTOP LL VERTE	Schiefer grün/flam	5,2	1,10	7	115,5	14.50

3.1.2 Swisspor BIKUTOP

Dampfbremsen	Oberfläche oben/unten	Dicke mm	Breite m'	Länge m'	m ² /Pal.	CHF/m ²
BIKUPLAN EGV3.5 v flam	Vlies/flam	3,5	1,00	10	200,0	7.60
BIKUVAP LL EVA *	ts/Vlies	3,5	1,10	8	193,6	7.80
BIKUVAP LL EVA flam	ts/flam	3,5	1,10	8	193,6	7.90

* solange Vorrat

Unterbahnen						
BIKUPLAN EGV3.5 v flam	Vlies/flam	3,5	1,00	10	200,0	7.60

Oberbahnen						
BIKUTOP LL forte schiefer hellgrau	flam	5.3	1,10	7	115,5	14.10
BIKUTOP EP5 flam *	ts/flam	5,0	1,00	8	120,0	11.00
BIKUTOP EP5 WF flam *	ts/flam	5,0	1,00	8	120,0	11.40
BIKUTOP EP5 WF S flam	Schiefer grau/flam	5,0	1,00	8	120,0	11.40
BIKUTOP EP5 S flam *	Schiefer grau/flam	5,0	1,00	8	120,0	11.00



3.1.3 Gründach-Abdichtung nach eco-bau

Dichtungsbahnen	Dicke mm	Breite m ¹	Länge m ¹	m ² /Pal.	CHF/m ²
Bikuplan ECO EGV 3,5 V	3,5	1,0	10	200,0	8.35
Bikutop PRO AQUA	5,0	1,0	8	120,0	15.40



* solange Vorrat

3.1.4 Swisspor Zubehör

Bituminöse Haftvermittler	Verbrauch g/m ²	Anwendungstemp.	l/Gebinde	CHF/l
Bitumenlack VS 100	ca. 150	+5 °C bis +40 °C	10 25 200	6.80 6.40
Bitumenlack VS BASIC	ca. 300	+5 °C bis +40 °C	25	3.80
BIKUPONTE Primer	ca. 150	+5 °C bis +40 °C	10 25	7.20 6.80
GREEN LINE Bitumenemulsion	ca. 150	+10 °C bis +40 °C	10 25	6.40 5.80



3.1.5 Bitumenkeile

	Breite/mm	Höhe/mm	m ¹ /Karton	Karton/Pal.	CHF/m ¹
Elastomer-Bitumenkeile	25	25	25	36	3.30



3.1.6 Flüssigkeitskunststoffe

BIKUCOAT, 1-komponentig	Verbrauch/m ²	kg/Gebinde	Gebinde/Pal.	CHF/kg
BIKUCOAT-Primer	0,1-0,3 kg	2,5	112	15.80
BIKUCOAT Primer 2K (Primer inkl. Härter zu Primer, Komponente A 1,4 kg, Komponente B 0,84 kg)	0,05 - 0,1 kg	2,24		36.70
BIKUCOAT-SMP Eco basaltgrau / lichtgrau	mind. 3 kg	4,0 12,5	112 45	36.50 32.00
BIKUCOAT-Alcalistop	mind. 1 kg	3,0 15,0		35.00 29.70



3.1.7 Bituminöse Haftvermittler

BIKUCOAT-Spezialvlies	Breite/mm.	m ¹ /Rolle	CHF/Rolle
	105	50	104.00
	150	50	114.00
	200	50	122.00
	300	50	155.00



3.1.8 Verarbeitungsset für Flüssigkunststoffe

Set mit Folie eingepackt in: 1 Kunststoff-Eimer, blau, 8 Liter	CHF/Stk
1 Flachpinsel	88.00
2 Kleinroller komplett, Moltopren	
6 Ersatzwalzen, (3 Moltopren/3 Nylon)	
1 Einweg-Handschuhe Latex weiss, gepudert (Karton zu 100 Stück)	
1 Abdeckband 3M	
1 Profi-Cuttermesser	
1 Rührstab, Kunststoff blau	
1 Tapezierschere inox, 280 mm	



3.2 Schutzbahnen

	Stärke in mm	Rollen-grösse /m	m ² /Palette	einzelne Rollen CHF/m ²	palettweise CHF/m ²
Bauschutzmatten (Gummigranulatmatten)	6	1,25 x 10	137,5	9.30	
	8	1,25 x 8	110,0	12.20	
	10	1,25 x 6	82,5	13.10	11.20
Swisspor TPO Wurzelschutzbahn,	1,2	2,0 x 20		12.50	
Swisspor Brandschutzvlies, 125 g/m ²		1,25 x 100		7.10	
Swisspor Protect 1000, Polypropylen Vlies, 1000 g/m ²		2 x 25		9.10	
FLN Bauma Bauschutzvlies, 300 g/m ²		1 x 25		3.78	
FLN FROMA Frost- und Bauschutzmatte, 300 g/m ²		2 x 30		3.36	

3.3 Bitumen-Dachschindeln

Bitumen-Dachschindeln	Paketinhalt	Farben	CHF/m ²
Rechteckige Form, 100x34cm	3 m ²	rot	23.09

3.4 Bitumen-Wellplatten

Onduline Bitumen-Wellplatten	Breite cm	Farben	CHF/Stk
Wellung 95/36 mm, Nutzbreite 85,5 cm			
Wellung 95/36 mm, Nutzbreite 85,5 cm	95	braun (grün/rot/schwarz)	25.81
Länge: 200 cm			
Firststück	50	braun (grün/rot/schwarz)	11.98



3.5 Wellpolyester-Dachplatten

Wellpolyester-Dachplatten	Materialstärke g/m ²	Plattenbreite cm	Farben	CHF/m ²
Plattenlängen: 1,5/2,0/2,5/3,0/3,5/4,0 m, längere auf Anfrage				
Wellung in mm				
76/18	690	90	natur	28.22
76/18	375	100	natur/grün/bronze	16.62

Viele weitere Sorten auf Anfrage



3.6 Befestigungsmaterial für Wellplatten

Befestigungsmaterial für Wellplatten	Grösse in mm	Stk/Beutel	CHF/Beutel
Unterlagsklötzli (Stützbügel)	76/18	10	3.25/Beutel
Plastikrondellen	zu 76/18	10	2.74/Paket
Gummirondellen	zu 177/51	100	5.80/Paket
Metallrondellen	zu 177/51	100	6.80/Paket
Befestigungsset für Wellung	76/18	20	7.35/Paket

3.7 Dach- Profilbleche

3.7.1 Profil W20/1100

Die Profilbleche werden auftragsbezogen nach Mass bestellt (Länge)
 Lieferfrist: ca. 7 – 14 Tage
 Standardfarben: Nadelgrün, dunkelgrau, rot, dunkelbraun, ziegelrot,
 Stärken 0,63mm + 0,75mm auch anthrazit, rotbraun, grauweiss

Artikel	Stärke in mm	Länge in mm	CHF/m ²
W-20/1100LR 25µm Polyester beschichtet	0,50	150-9000	27.00
	0,63	150-10000	31.00
	0,75	150-11000	36.00

-> bei Bestellungen unter 30m² gibt es einen Zuschlag von CHF 44.00

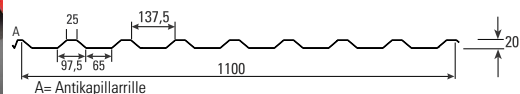
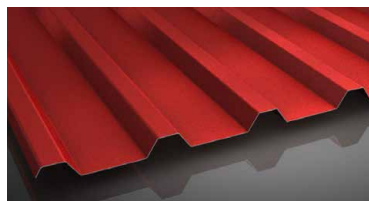

Plattenbreite: 1135 mm, Nutz-/Abrechnungsbreite: 1100 mm

3.7.2 Wellblech Sinus

Dach-Wellbleche

Artikel	Stärke in mm	Breite in cm	Länge in cm	CHF/Stk
W-1/1064 LR rotbraun	0,63	112	200	50.00
	0,63	112	250	62.00
76/18 galvanisiert		80	200	50.79





Holz & Isolationen



4.0 Holz/Hobelwaren

4.0.1 Latten, Fichte/Tanne, roh 	Dimension mm	Stk/Bund	Längen m	einzel CHF/m ¹	bundweise CHF/m ¹
Dachlatten	24/48	10	2 / 2,5 / 3 / 4 / 5	1.10	0.96
Gipslatten	7/27	100	2 / 2,5	0.85	0.72
Doppellatten	50/50	6	2,5 / 3 / 4 / 5	2.70	-
Doppellatten	60/60	4	3 / 4 / 5 / 6	3.50	-

4.0.2 Kanthölzer, Fichte/Tanne, roh, trocken 	Stk/Paket	Dimension cm	Länge m	einzel CHF/m ¹	paketweise CHF/m ¹
Kantholz	96	6 / 8	5	5.00	4.00
Kantholz	96	6 / 10	5	6.25	
Kantholz	30	8 / 8	5	6.60	5.40
Kantholz	40	8 / 12	3/4/5	7.40	6.20

4.0.3 Bretter, Fichte/Tanne, roh 	Stk/Paket	Dimension mm	Länge m	einzel CHF/m ²	paketweise CHF/m ²
Schalbretter	120	27	5	23.50	18.50
Gerüstbretter	40	45 x 250	3 / 4 / 5	29.50	23.00

4.0.4 Holzdreikantleisten	Dimension mm	Holzart	einzel CHF/m ¹	bundweise CHF/m ¹
Dreikantleisten	10 / 10	diverse	0.60	0.50
	15 / 15	diverse	0.80	0.70
	20 / 20	diverse	1.10	1.00
	25 / 25	diverse	1.35	1.25
	30 / 30	diverse	2.00	1.70

4.0.5 Schaltafeln	Stärke mm	Stk/Paket	Platten-grösse cm	einzel CHF/m ²
Schaltafeln gelb, Import EU Paketweise = Tagespreise!	27	40	150 x 50	33.50
	27	40	200 x 50	33.50
	27	40	250 x 50	33.50
	27	40	300 x 50	33.50
Buttholz-Schaltafeln braun, hergestellt in der Schweiz  Paketweise = Tagespreise!	27	40	200 x 50	39.00
	27	40	250 x 50	39.00
	27	40	300 x 50	39.00
	27	40	250 x 100	46.00



4.0.6 OSB-3 Verlegeplatten	Stärke mm	Stk/Paket	Platten-grösse cm	einzel CHF/m ²
Formaldehydfrei verleimt	15	60	250x67,5	9.90
	18	50	250x67,5	12.80
	22	42	250x67,5	15.20
	25	36	250x67,5	18.50



4.0.7 Pavatex	Stärke mm	Format cm	Stk/Paket	paketw. CHF/m ²	einzel CHF/m ²
Hartfaserplatten	3,2	244 x 122	150	4.60	5.80

4.1 Swisspor EPS (expandierter Polystyrol-Hartschaum)

Polystyrol-Hartschaumplatten  (Styroporplatten) Format 100 x 50 cm, verpackt in Plastikfolie Stärke in mm	m ² /Paket	EPS 15 CHF/m ²
10	25,0	1.50
15	16,0	2.30
20	12,5	2.60
25	10,0	3.30
30	8,0	3.90
40	6,0	5.20
50	5,0	6.60
60	4,0	7.90
80	3,0	10.50
100	2,5	13.10
120	2,0	15.70
150	1,5	19.70
200	1,0	26.20
250	1,0	32.80
300	0,5	39.30
500	0,5	65.50

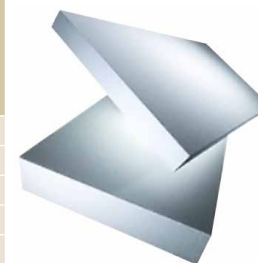

4.2 XPS extrudierte Polystyrolschaumplatten

4.2.1 Swisspor XPS 300SF  glatte Oberfläche, Platten allseitig gefälzt, Rohdichte mind. 33 kg/m ³ , Format 125x60 cm	Stärke in mm	m ² /Paket	Platten/Paket	CHF/m ²
20 (ohne Falz)	15,00	20	9.00	
30	10,5	14	9.30	
40	7,50	10	12.40	
50	6,00	8	15.50	
60	5,25	7	18.60	
80	3,75	5	24.80	
100	3,00	4	31.00	
120	2,25	3	37.20	
140	2,25	3	43.40	
160	2,25	2	49.60	
180	1,50	2	58.50	
200	1,50	2	65.00	



4.2.2 Swisspor XPS 300 GE
 rauhe Oberfläche, Rohdichte ca 33 kg/m³
 Stärke in mm

Stärke in mm	m ² /Paket	Stk./Paket	gefiert CHF/m ²
10	30,00	40	10.00
20	15,00	20	9.00
30	10,50	14	9.60
40	7,50	10	12.80
50	6,00	8	16.00
60	5,25	7	19.20
80	3,75	5	25.60
100	3,00	4	32.00
120	2,25	3	38.40
140	2,25	3	44.80
160	2,25	3	51.20
180	1,50	2	60.30
200	1,50	2	67.00



4.2.3 Swisspor PIR
 Polyurethan-Hartschaum mit beidseitiger Kaschierung,
 Format ohne Stufenfalz 1200 x 600 mm, Grossformat 2400 x 1200 mm
 auf Anfrage, Stufenfalz ab 50 mm möglich, Falztiefe 15 mm

Dicke mm	m ² /Bund	Platten/Bund	PIR Vlies CHF/m ²	PIR Alu CHF/m ²	PIR Premium CHF/m ²	PIR Premium Plus CHF/m ²
20	14,40	20	11.80	15.00	17.10	19.70
30	11,52	16	15.10	17.50	20.40	24.30
40	8,64	12	17.90	20.10	23.60	28.80
50	7,20	10	20.60	22.70	26.30	32.80
60	5,76	8	21.80	25.10	28.90	38.10
70	4,32	6	25.00	28.80	32.50	42.80
80	4,32	6	26.50	30.80	34.40	45.30
100	2,88	4	30.50	35.00	41.00	54.00
120	2,88	4	36.60	42.00	49.20	64.80
140	2,16	3	42.70	49.00	57.40	75.60

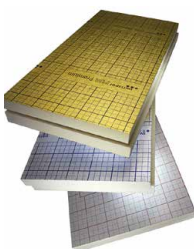

4.3

PE- Randstellstreifen

Stärke in mm	Breite cm	m/Rolle	Rollen/Paket	CHF/Rolle
8	10	50	6	16.25
8	12	50	5	19.35
8	15	50	4	24.85
mit Folie 8mm	12	25	8	29.70
Pecitape silent, selbstklebender Randdämmstreifen	5	20	4	63.00
Mapei Mapesilent Band R	5	50	5	157.50
Mapei Mapestrip Perimeter	5	20	5	61.80



4.4 Ytong Multipor® Mineraldämmsystem

Ytong Multipor® Mineraldämmplatten
WI für Innen Lambda $\lambda = 0,042$ (ab 60mm)
 Multipor Mineraldämmplatten feuerfest und faserfrei

Abmessungen (D x H x L) in cm	m ² pro Paket	m ² pro Palette	Paketweise CHF/m ²	Palettweise CHF/m ²
5 x 39 x 60	1,872	33,70	27.73	23.80
6 x 39 x 60	2,34	28,08	33.58	29.20
8 x 39 x 60	1,17	21,06	44.73	38.90
10 x 39 x 60	1,404	16,85	54.62	47.50
12 x 39 x 60	1,17	14,04	64.63	56.20
14 x 39 x 60	0,94	11,23	75.78	65.98
16 x 39 x 60	0,702	9,83	85.67	74.50
18 x 39 x 60	0,702	8,42	96.83	84.20
20 x 39 x 60	0,702	8,42	108.10	94.00

Zusatzprodukte

Leichtmörtel	20 kg	40/Pal.	53.00	47.00
Füllmörtel zum ausbessern	12,5 kg	63/Pal.	45.00	40.50

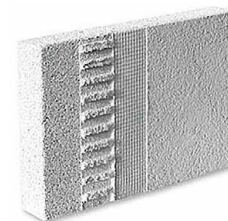

➔ **Multipor Aussenwärmendämmung WAP auf Anfrage**

4.5 Steinwolle-Isolierprodukte

4.5.1 Swisspor ROC Typ 1

Lambda $\lambda_D = 0,036$ W/mK
 ca 30 kg/m³, Format 100 x 60 cm

Plattenstärke in mm	m ² /Paket	Stk./Paket	CHF/m ²
30	9,60	16	4.90
40	7,20	12	6.10
50 (auch 62,5 cm breit)	7,20	12	7.60
60	4,80	8	9.00
80	3,60	6	10.60
100	3,60	6	13.30
120	3,00	5	16.00
140	2,40	4	18.60
160	1,80	3	21.20
180	1,80	3	24.10
200	1,80	3	26.60





**Mehr Licht. Mehr Luft.
Mehr Leben.**

- ▶ **Dachfenster**
- ▶ **Flachdach-Fenster**
- ▶ **Hitzeschutz**

Baumaterial Späth - Ihr Velux-Vertriebspartner

Bringt Licht ins Leben



4.5.2 Swisspor ROC Typ 3 $\lambda_D = 0,034 \text{ W/mK}$
ca. 60 kg/m³, Format 100 x 60 cm

Plattenstärke in mm	m ² /Paket	Stk/Paket	CHF/m ²
30	9,60	16	7.70
40	7,20	12	10.40
50	7,20	12	12.70
60	4,80	8	15.00
80	3,60	6	19.70
100	3,60	6	24.60
120	2,40	4	29.30
140	2,40	4	34.50
160	1,80	3	39.30
180	1,80	3	44.10
200	1,80	3	49.00



4.5.3 Steinwool-Isolierplatten $\lambda_D = 0,035 \text{ W/mK}$
ca 115 kg/m³, Format 120 x 62,5 cm

Plattenstärke in mm	m ² /Paket	Platten/Paket	CHF/m ²
20, Swisspor ROC TS 5	7,50	10	7.60
30, Swisspor ROC TS 5	6,00	8	10.60
25, Swisspor ROC TS 5 ($\lambda_D = 0,037$)	6,00	8	10.10
12 / 10, Isover PS 81 (Glaswolle)	20,25	27	5.65

4.6 Glaswolle

Sparrenrollen SF 35 Glaswolle (diverse Lieferanten) Selbstklebende Bahnen ohne Beschichtung, Rohdichte p ca. 17-20 kg/m³

Stärke in mm	m ² /Rolle	CHF/m ²
100	6,72	13.80
120	5,76	16.80
140	4,80	19.70
160	4,20	21.30
180	3,84	23.60
200	3,36	25.60
220	3,36	29.10
240	3,12	31.30



4.7 Dampfbremsen/Sperren

Dampfbremsen LDPE, EVA, Polyamid, B1	Dimension	CHF/m ²
Starvap TM 100 (weiss)	0,2 mm stark 2 x 50 m	1.40



**Unser Lagerteam findet
die passende Lösung.**

4.8 SIGA-Produkte



4.8.1	Dichtbänder für Innenanwendung		Stk. /VE	einzel CHF/Stk.	VE CHF/Stk
	Corvum 30/30	30/30 mm, 25 m	10	55.38	50.31
	Corvum 12/48	12/48 mm, 25 m	10	55.38	50.31
	Dockskin 100, Hochleistungsprimer	1 kg	8	37.48	34.05
		4 kg	1	129.93	–
	Fentrim 20, 100	15/85 mm x 25 m	6	77.95	70.82
	Fentrim 20, 150	15/135 mm x 25 m	4	114.02	103.58
	Primur Kartusche	310 ml	12	11.71	10.64
	Primur Schlauchbeutel	600 ml	12		19.15
	Rissan 60	60 mm x 25 m	10	24.56	22.31
	Rissan 100	100 mm x 25 m	6	64.96	59.01
	Rissan 150	150 mm x 25 m	4	94.19	85.52
	Sicrall 60	60 mm x 40 m	10	31.45	28.57
	Sicrall 170	170 mm x 40 m	1	126.16	–
4.8.2	Dichtbänder für Aussenanwendung				
	Fentrim 2, 50/85	50/85 mm x 25 m	6	106.50	96.75
	Fentrim 2, 100	100 mm x 25 m	6	82.14	74.62
	Fentrim 2, 150	15/135 mm x 25 m	4	119.65	108.68
	Fentrim IS 2, 75 mm	75 mm x 25 m	8	64.18	58.30
	Fentrim IS 2, 100 mm	100 mm x 25 m	6	77.95	70.82
	Fentrim IS 2, 150 mm	150 mm x 25 m	4	114.02	103.85
	Nageldicht-Band	50 x 4 mm x 30 m	10	60.77	55.21
		70 x 4 mm x 30 m	7	79.09	71.85
	Twinet 20	20 mm x 50 m	10	44.75	40.63
	Wigluv 20/40	20/40 mm x 25 m	10	50.19	45.60
	Wigluv 60	60 mm x 40 m	10	42.60	38.76
	Wigluv 100	100 mm x 40 m	6	66.38	60.30
	Wigluv 150	150 mm x 40 m	4	95.49	86.75
	Wigluv black 60	60 mm x 40 m	10	64.96	59.01
4.8.3	Bahnen				
	Majcoat 200 SOB, Unterdeckbahn mit Kleberand	1,5 x 50 m		398.73	
	Majcoat 200, Unterdeckbahn	1,5 x 50 m		312.95	
	Majpell 5, Dampfbremse (innen)	1,5 x 50 m		241.81	
	Majpell 5, Dampfbremse (innen)	3,0 x 50 m		483.81	
	Majpell 25, Dampfbremse (innen)	1,5 x 50 m		241.81	
	Majrex 200, Dampfbremse Hydrobrid	1,5 x 50 m		418.79	
	Majvest 200, Fassadenbahn	1,5 x 50 m		235.03	
	Majvest 200, Fassadenbahn	3,0 x 50 m		469.88	
	Majcoat 350, Unterdeckbahn	1,5 x 33,4 m		566.89	
	Manschette Ø 80 -125 mm	10		36.50	32.90

Eisenwaren

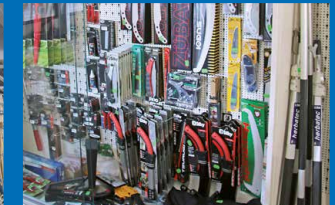

BAUMATERIAL SPÄTH
Bau- und Gartenbedarf

5.1 Nägel

5.1.1 Stifte flach, blank	Inhalt g/Paket	CHF/Paket	Pakete zu 1 kg CHF/kg	Pakete zu 2,5 kg CHF/kg	Pakete zu 5 kg CHF/kg
Masse in mm	500	17.50			
1,4 x 25					
1,6 x 30			25.95		
2,0 x 40			19.40		
2,0 x 50			18.40		
2,5 x 60				7.50	
2,8 x 70				7.50	
3,1 x 80				7.50	
3,5 x 90				7.50	
4,0 x 100				7.50	
4,5 x 120					17.35
6,5 x 180					10.45
7,5 x 245					10.45
8,5 x 275					10.45
8,5 x 300					10.45

5.1.2 Dachpappenstifte verz.

Masse in mm	kg/Paket	CHF/kg
2,5 x 20	2,5	43.70
2,5 x 25	2,5	41.20
2,5 x 30	2,5	39.50

5.1.3 Agraffen verzinkt

Masse in mm	kg/Paket	CHF/kg
1,8 x 20	0,5	37.55
2,5 x 27	0,5	27.55
2,8 x 30	1,0	21.15
3,5 x 35	1,0	20.10
4,0 x 40	1,0	19.70

5.2 Befestigungstechnik

Grosses Befestigungs-Sortiment an Lager! Schrauben/Dübel/Beschläge



5.3 Plastikfolien, Planen

5.3.1 Bauplastik, transparent, 1. Qualität (für Grossbezüge gelten Tagespreise)

Masse in m	Stärke mm	Gewicht/Rolle kg	CHF/kg
2,0 x 50	0,10	9,2	6.50
3,0 x 50	0,10	13,8	6.50
4,0 x 50	0,10	18,4	6.50
2,0 x 50	0,15	13,8	5.00
3,0 x 50	0,15	20,7	5.00
4,0 x 50	0,15	27,6	5.00
2,0 x 50	0,20	18,4	6.50
3,0 x 50	0,20	27,6	6.50
4,0 x 50	0,20	36,8	6.50
6,0 x 50	0,15	41,4	7.20
8,0 x 25	0,15	27,6	9.00



5.3.2 Oeko Bauplastik, gräulich (transluzent)

Masse in m	Stärke mm	Rollen/Palette	Gewicht kg/Rolle	CHF/kg
2,0 x 50	0,15	50	13,8	2.90
3,0 x 50	0,15	50	20,7	2.90
4,0 x 50	0,15	30	27,6	2.90



5.3.3 Bauplastik, schwarz

Masse in m	Stärke mm	Gewicht kg/Rolle	CHF/kg
2,0 x 50	0,15	13,8	5.20
3,0 x 50	0,15	20,7	5.20
4,0 x 50	0,15	27,6	5.20

5.3.4 HDPE-Sparfolie aus Rezyklat (Malerfolie)

2 x 100 m	CHF/Rolle
	19.90

5.3.5 Planen

Delta Plan 1500 E	mit Ösenband, 30 x 4 m	CHF/m²
Delta Plan 2000	ohne Ösenband, 30 x 4 m	6.40
Teguplan C1	Gerüstpläne, 4 x 30 m	3.30
Monarflex Ultra	ohne Ösen 4 x 25m	6.60
	mit Ösen, 4 x 30m	6.90

DIE BOX OFFEN FÜR ALLES

Diese extrem stabilen Transportboxen aus 3 mm starkem legiertem Aluminium-Riffelblech eignen sich u.a. hervorragend als Pritschenboxen für Handwerker, Bauunternehmen, Garten- und Messebau - überall dort, wo grosse und sperrige Gegenstände sicher transportiert und verstaut werden müssen.

Die staub- und spritzwassergeschützten Ausführungen in praxisgerechten Grössen mit massiven Exzenterverschlüssen, Gasdruckfedern, Vollverschweissung und Edelstahlbeschlägen bieten besten Schutz bei jedem Wetter.

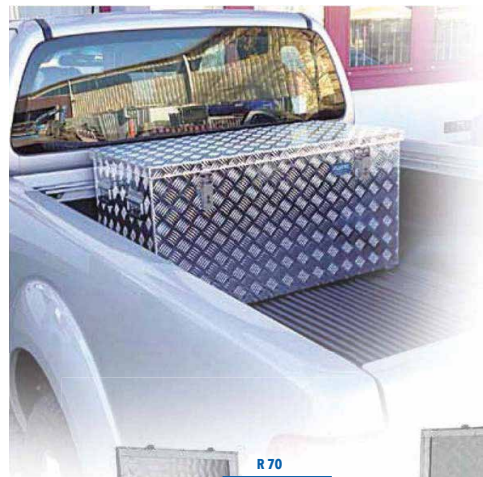

**AUS 3 MM
STARKEM
ALUMINIUM**

UF Unterflur Serie

★★★★★
MADE IN EUROPE

alle Preise exkl. MwSt

5.3.6 PE-Gewebeplanen	leichte Ausf. ca. 75 g/m ² CHF/Stk	grün/blau ca. 150 g/m ² CHF/Stk	Transparent ca. 170 g/m ² CHF/Stk
Wasserdicht, allseitig pro Meter eine Metallöse			
Masse in m			
ca. 2 x 3	7.45	14.25	21.70
ca. 3 x 4	14.25	-	43.40
ca. 3 x 5	18.30	-	-
ca. 4 x 5	-	47.85	-
ca. 4 x 6	28.55	-	86.70
ca. 5 x 8	-	95.80	-
ca. 4 x 10	-	-	144.80
ca. 6 x 10	-	144.80	-
ca. 8 x 12	-	231.25	-



5.3.7 PE-Bändchengewebeplanen (Blachen)	ca. 250g/m ² grün, extra-stark, allseitig alle 50cm eine Metallöse	CHF/Stk
Masse in m		
6 x 8		167.90
6 x 10		208.60
8 x 10		280.65
8 x 12		333.75
10 x 12		417.20
10 x 15		525.40
12 x 15		631.65
10 x 20		699.65

5.4 Dachrinnenschlauch für provisorische Abläufe aus Polyäthylenfolie	m/Rolle	CHF/Rolle
0,1 mm stark	100	38.00
0,2 mm stark (forte)	100	72.00



5.5 Zip-Door Folientüren Komplettsset mit Reissverschluss	VE	CHF
210 x 110 cm	10	31.50
	Typ U	
	Typ L	31.50
310 x 130 cm	10	34.00
	Typ L Plus	
	Magnet	39.00



5.5.1 Reissverschluss Set Selbstklebend	VE	CHF/Set
2-er Set, 2m lang	20	32.00



5.6 Klebebänder, Abdeckmaterial

5.6.1 Abdeck-Klebebänder norm. Qualität, Permafix 124 Masse mm x m	Rollen/Karton	einzel CHF/Rolle	kartonweise CHF/Rolle
19 x 50	48	2.40	1.80
25 x 50	36	2.90	2.30
30 x 50	32	3.60	2.70
38 x 50	24	3.80	3.10
50 x 50	24	4.70	4.00
75 x 50	12	7.20	6.70
100 x 50	12	9.20	8.20



5.6.2 Betonklebbänder, gelb	Masse mm x m	Rollen/Karton	einzel CHF/Rolle	kartonweise CHF/Rolle
PVC-Betonband Permafix 212	50 x 33	18	11.00	8.80
Gewebe-Betonband Permafix 290	44 x 50	28	8.00	6.80
Gewebe-Betonband Permafix 293	50 x 50	24	14.00	12.80

5.6.3 Diverse Selbstklebebänder	Masse mm x m	Farbe	CHF/Rolle
Doppelklebband (Teppichband)	50 x 25	beige	10.00
Isolierband	19 mm	schwarz	4.95

5.6.4 Abdeckpapier Packzellulose 270 g/m ²	einzel CHF/kg	ganze Palette CHF/kg
1,5 m breit, ca. 20 kg/Rolle, nur ganze Rollen, 50 m	2.20	1.90

5.6.5 Floorliner® Schutz- und Abdeckvlies original Landolt 	CHF/m ²
1 oder 2 m breit, Rollen zu 50 m, nur ganze Rollen (180 g/m ²)	2.52



5.6.6 Diverse Bodenabdeckvliese	Dimension	Rlen/Pal.	CHF/m ²
Permafix Standard, ca 180 g/m ²	100 cm breit, 50 m lang	12	1.28

5.6.7 Thumasole blu (dampfoffene Schutzabdeckung)	CHF/m ²
1 m breit, Rollen zu 50 m, nur ganze Rollen	3.15

5.6.8 Spezial-Schutzvlies «ALLPROTECT» by Landolt 	Dimension	Rlen/Pal.	CHF/m ²
Schutzvlies mit haftender PE-Folie und rutschfester Oberfläche ca 2,5 mm stark, ca 350 g/m ²	100 cm breit, 25 m lang	15	7.56



5.6.9 Betonschutzbahn Betontherm®	Dimension	CHF/m ²
10 mm stark	1,5 x 50 m	3.40

5.7

Schuhkratz-Gitterroste verz. Maschenweite 40/10 mm	CHF/Stk	25 x 25 x 3 mm Winkelrahmen Grösse mm	CHF/Stk
Rost-Grösse in mm			
390 x 590	57.00	400 x 600	53.00
390 x 790	64.00	400 x 800	64.00
490 x 790	80.00	500 x 800	69.00
490 x 990	100.00	500 x 1000	79.00



5.8

Ventilationseinsätze, rund, mit Stutzen	Verzinkt mit Gitter o. Fliegengitter CHF/Stk	Alu mit Wetterlamellen CHF/Stk
Ø in mm		
75		25.00
95	19.00	25.00
115	25.00	30.00
145	27.00	34.00
190	38.00	45.00
245	56.00	

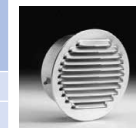

5.9

Revisions Einbautüren verz., weiss mit 4 Kant Verschluss, inkl. Rahmen	CHF/Stk
Aussparungsmass in mm	
200 x 200	36.80
300 x 300	43.50
400 x 400	51.00
500 x 500	58.50



ART. 186100

WORKING XTREME
WINTERJACKE MIT STRETCH



ART. 117300

WORKING XTREME
SOFTSHELLJACKE



wasserdichte
**DIE WELTWEIT BREITESTE
STRETCH-KOLLEKTION**



AUCH ALS WARNFARBEN VORRÄTIG



**UNBEGRENZTE
MÖGLICHKEITEN** **EINZIGARTIGES
WASSERDICHTES
KONZEPT**

ART. 182401

WORKING XTREME
KOMBIHOSE MIT STRETCH



ART. 182400

WORKING XTREME
STRETCHBUNDHOSE



ART. 186000

WORKING XTREME
STRETCHJACKE

FÜR ZIP-IN JACKE VORBEREITET



5.10 FORTAL Alu -Mehrzweckleitern

2-teilig, verstärkte Ausführung			
Modell	Höhe	kg	CHF/Stk
T2A180 - 2 x 6 Sprossen	1,88 / 3,00 m	9,0	213.85
T2A210 - 2 x 7 Sprossen	1,95 / 3,51 m	9,8	222.70
T2A238 - 2 x 8 Sprossen	2,22 / 2,38 m	11,2	247.50
T2A294 - 2 x 10 Sprossen	2,72 / 4,91 m	13,5	290.00
T2A351 - 2 x 12 Sprossen, mit Seilzug	3,23 / 6,03 m	18,8	406.00
T2A407 - 2 x 14 Sprossen, mit Seilzug	3,73 / 7,15 m	20,8	465.00

3-teilig, verstärkte Ausführung			
Modell	Höhe	kg	CHF/Stk
T3A210 - 3 x 7 Sprossen	3,27 / 4,90 m	13,8	342.20
T3A238 - 3 x 8 Sprossen	3,74 / 5,74 m	18,2	425.80
T3A294 - 3 x 10 Sprossen	4,49 / 6,85 m	22,0	504.17
T3A351 - 3 x 12 Sprossen, mit Seilzug	5,05 / 7,98 m	27,5	634.50



5.11 Alu-Ladeschienen «Baytec»

Verladeschiene ohne Rand für grosse Fahrflächenbreite neu	Länge	Breite	Tragkraft/Paar	CHF/Paar
AO 30/06	3000 mm	250 mm	600 kg	720.00
BO 26/28	2650 mm	350 mm	2800 kg	1076.00
BO 31/22	3110 mm	350 mm	2200 kg	1190.00
BO 31/37	3130 mm	380 mm	3700 kg	1420.00
BO 36/30	3590 mm	380 mm	3100 kg	1550.00





alle Preise exkl. MwSt

5.12 Abfallbehälter, Kehrriech-Container

Norm-Abfallbehälter aus Kunststoff	Inhalt Liter	CHF/Stk
140 Liter grün oder anthrazit	140	58.00
240 Liter grün oder anthrazit	240	62.00
360 Liter grün oder anthrazit	360	134.00
Norm-Kehrriech-Container aus Kunststoff		
660 Liter grün oder anthrazit	660	420.00
770 Liter grün oder anthrazit	770	433.00
Mehrpreis zu 770 Liter		
Fusspedal Deckelheber		160.00
Vierkantschloss		58.00
Automatik-Kippschloss		160.00
Norm-Kehrriechcontainer Stahl, verzinkt		
mit eingebautem Deckelheber + 1 Bremse	600	850.00
L X B x H: 130 x 85 x 125 cm	800	795.00
Mehrpreis zu 800 Liter		
Pilz-Schloss		25.70
Vierkantschloss mit 2 Schlüsseln		62.00
Fusspedal-Deckelöffner		252.00
Container-Einlegesäcke, 50 Stk/P.	800	2.35



PROPANGAS ZUM TOPPREIS!

Ihre Verkaufsstelle in der Region

BAUMATERIAL SPÄTH
Bau- und Gartenbedarf

Falkensteinerstrasse 13, 4132 Muttenz
061 641 13 51, www.späth.ch

Öffnungszeiten

Mo-Fr 06.45 bis 17.00 Uhr
(November-März: 07.15 bis 17.00 Uhr)

5.13 Propangas und Camping-Gas

Propangas «Flaga» in Stahlflaschen, Preise inkl. CO²-Abgabe! (inkl. TZ, Stand 1.2.2024)
Spezialkonditionen für Grossbezüger

	Menge		CHF/Stk
Propangas	10,5 kg	Füllung	44.20
Propangas Tauchrohrflasche	10,5 kg	Füllung	44.20
Propangas	5,0 kg	Füllung	34.00
Propangas	33,0 kg	Füllung	144.00
Flaschendepot		für Stahlflaschen	netto 55.00



Propangas «Flaga» in Kunststoffflaschen, Preise inkl. CO²-Abgabe!
Spezialkonditionen für Grossbezüger

	Menge		CHF/Stk
Propangas	10 kg	Füllung	46.00
	5 kg	Füllung	34.00
	7,5 kg	Füllung	42.50
Flaschendepot		für Kunststoffflaschen	netto 65.00



Die Nummer 1 bei Flüssiggas
www.flaga.ch

 **FLAGA**

www.späth-shop.ch

BAUMATERIAL SPÄTH
Bau- und Gartenbedarf

5.14 Kraftstoff

Husqvarna XP Power 2 Achtung Tagespreise! Zweitaktkraftstoff

	Menge	CHF
Alkylatkraftstoff	5 l	26.83
	25 l	130.43
	200 l	* 840.00



Husqvarna Power 4 Achtung Tagespreise! Viertaktkraftstoff

	Menge	CHF
Alkylatkraftstoff	5 l	25.90
	25 l	125.81
	200 l	* 800.00



* auf Bestellung

Links in den Späth Webshop

Probst Baustellengeräte



Werkzeug



Arbeitskleidung



5.15

Arbeitsschutzprodukte Bekleidung

Artikel	Qualität	Stk/VE	einzel Verkaufspreis CHF
Arbeitshandschuhe Art. 5020	Rindspaltleder 1,2 mm, mit Stoffrücken, grau, Gr. 10	10/100	4.20/Paar
Arbeitshandschuhe Art. 5100	Rindnarbenleder 1,3 mm, mit Stoffrücken, Gr. 7 – 12	10/100	6.40/Paar
Arbeitshandschuhe Art. 6400	Rindnarbenleder 1,1 mm, Griffsicher, beige, Gr. 7 – 11	10/100	12.40/Paar
Arbeitshandschuhe Art. 5180	Rindnarbenleder, ganz gefüttert mit Webpelz, Gr. 10,5	10/100	7.75/Paar
Schutzhandschuhe SHOWA 310 green	aus Baumwollgestrick mit Nitril-Teilbeschichtung, grün, Gr. 7 – 10	10/120	3.25/Paar
Schutzhandschuhe SHOWA Thermo 451 grau	aus moltoniertem Baumwollgestrick mit Naturlatex-Beschichtung, grau, Gr. 7 – 10	10/120	4.20/Paar
Einweghandschuhe verschiedene Modelle	100 Paar/Paket Grössen: S - XL	10/100	ab 10.40/Paket
Latexhandschuhe Art. 4020	Naturlatex 0,6 mm, 32 cm lang für Maurer etc., gelb	10/100	2.00/Paar
Regenjacke mit Kapuze	Polyamidgewebe PVC-beschichtet, gelb	20	29.00/Stk
Regenhose Rainstar	Polyamidgewebe PVC-beschichtet, gelb	20	18.30/Stk
Wetterhut	imprägnierter Wollfilz, schwarz Grössen 55 - 61	20	55.00/Stk
Warnweste gelb	mit Reflexstreifen	30	ab 8.25/Stk
Schutzbrillen	diverse Modelle an Lager		ab 6.90/Stk
Kapsel-Gehörschutz	diverse Modelle an Lager		ab 32.85
Partikelmasken verschiedene Modelle	Feinstaubmasken Sekur Willson 20 Stk/Paket	10 Pakete	ab 25.20/Paket
Filzüberziehpanntoffeln	Grössen 40 - 50		39.93/Paar

Grosses Lagersortiment an Arbeits- und Freizeitschuhen, sowie T-Shirts, Sweatshirts etc.
Verlangen Sie unsere Offerte für bedruckte oder bestickte Kleider.



5100



310



451



Filzpanntoffel

Lastwagen



Mit unserem 3-Achs-Lastwagen mit Kran können wir für Sie auch Versetzarbeiten ausführen.

Gesamtgewicht: 26 to, mit Anhänger 40 to

Nutzlast: 12,5 to, mit Anhänger 22 to

Ladefläche Lastwagen: 2,48 x 6,20 m

Ladefläche Anhänger: 2,47 x 5,25 m

Ausladung des Krans: 10,3 m

Zubehör zu Kran: • vollhydraulische Palettgabel

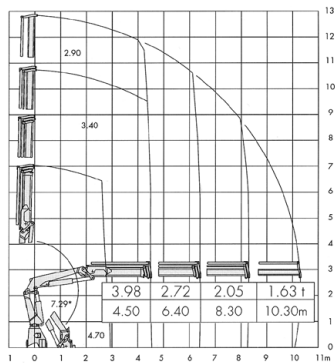

Paletten Infos



Art	Grösse	Rechnung CHF	Gutschrift CHF
Euro Palette	120 x 80 cm	25.00	20.00
Birkenmeier Palette	120 x 80 cm	25.00	20.00
Kronimus Palette	120 x 80 cm	30.00	25.00
Lithon Plus Palette	120 x 80 cm	28.00	24.00
Eternit Formereipalette	120 x 100 cm	28.00	23.00
Eternit Gartenpalette	120 x 120 cm	35.00	28.00
ST Palette	120 x 80 cm	33.00	28.00
Trutmann Palette	100 x 50 cm	20.00	18.00
Gipskarton Palette	250 x 125 cm	42.00	37.00
	200 x 125 cm	42.00	37.00
	250 x 60 cm	42.00	37.00
Kronimus Werks Palette	100 x 100 cm	30.00	25.00
LP Palette	100 x 100 cm	28.00	24.00
LP Kantholzpalette	100 x 200 cm	100.00	95.00
Ytong Palette		16.00	12.00

Beschädigte Paletten werden nicht zurückgenommen!

- ✗ Latte fehlt
- ✗ Latte gebrochen
- ✗ Latte gesplittert
- ✗ Klötze fehlen
- ✗ Morsch oder von Pilzen befallen
- ✗ bemalt oder lackiert
- ✗ keine Stempel (EUR oder Bahn, Hersteller)
- ✗ Einweg Paletten



Allgemeine Verkaufs- und Lieferbedingungen – Bitte beachten

Allgemein

Diese Bedingungen gelten für alle Geschäftsbeziehungen zwischen Baumaterial Späth AG und allen Kunden. Diese werden nur durch spezielle schriftliche Vereinbarungen aufgehoben. Diese Preisliste verpflichtet uns nicht zur Lagerhaltung! Abbildungen, Farbmuster, Mass- und Gewichtsangaben in der Preisliste können variieren und sind nicht verpflichtend.

Preise

Die Preise verstehen sich in CHF, ab Lager Muttenz abgeholt.

Sämtliche Preise sind freibleibend, die Anpassung an Tagespreise bleibt vorbehalten!

Die MwSt ist in den Preisen nicht enthalten.

Lieferbedingungen

Transporte ab Lager Muttenz werden nach Aufwand verrechnet. Für Werks-Transitlieferungen gelten die Lieferbedingungen des Lieferwerks. Kranablad wird extra in Rechnung gestellt, der Kunde hat beim Entlad Hilfe zu leisten. Schadenersatzansprüche infolge verspäteter Lieferung, im speziellen aufgrund von Staus oder Lieferschwierigkeiten der Lieferwerke können nicht akzeptiert werden. Die Waren müssen vom Kunden bei Abholung und Lieferung kontrolliert werden. (Korrektheit, Mengen und Beschädigungen). Werden Produkte bemängelt, so muss die Reklamation unverzüglich erfolgen, spätestens 1 Woche nach Erhalt, die Mängel sind genau zu bezeichnen, am besten auch mittels Foto zu belegen. Mangelhaftes Material darf keinesfalls verarbeitet werden, Folgekosten gehen zu Lasten des Kunden. Wir haften nicht für falsche Anwendung des gelieferten Materials.

Zahlung

Grundsätzlich sind die Rechnungen innert 30 Tagen netto zahlbar. Neukunden nur gegen Bar/Karte. Bei Zahlungsverzug wird ein Verzugszins von 5 % verrechnet und wir behalten uns vor, nur noch gegen Bar oder Vorauskasse zu liefern.

Warenretouren

Einwandfreie, originalverpackte Lagerartikel werden innert 8 Tagen nach Bezug zurückgenommen, für unseren Aufwand werden 20 % vom Bruttowert in Abzug gebracht. Sonderanfertigungen oder Artikel welche extra für den Kunden bestellt worden sind, können nicht zurück genommen werden.

Betonwaren

Ausblühungen, Kalkausscheidungen und leichte Farbunterschiede können bei jedem Betonprodukt vorkommen und berechtigen nicht zu Beanstandungen. Salz schadet dem Beton. Sickersteine dürfen keinesfalls gesalzen werden!

Lagerhaltung

Diese Preisliste verpflichtet uns nicht zur Lagerhaltung aller aufgeführten Artikel!

Gerichtsstand

Gerichtsstand ist Liestal

A

Abdeck-Klebebänder.....	196
Abdeckpapier Packzellulose.....	196
Abdichtungsprodukte.....	130
Abfallbehälter.....	201
Abschrankungssockel.....	70
Abstandhalter für Platten.....	32
Abzweiger.....	171
Aco-Bauguss.....	155
Aco-Rinnen.....	159
Aco-Schachtboden.....	152
Acryl-Dichtmasse.....	137
Agraffen.....	62 192
Akazienpfähle.....	91
Alba-Platten.....	144
All in One Foam.....	141
Allprotect-Schutzvlies.....	196
Alu-Eckputzprofil.....	145
Alu -Mehrzweckleitern.....	199
Alu-Rasenkanten.....	68
Anschlaghalterungen RISA 2000.....	150
Ansetzbinder.....	130
Antik-Pflaster.....	56
AquaDrain.....	39
Arbeitshandschuhe.....	203
Arbeitsschutzprodukte Bekleidung.....	203
ArborAnker.....	115
Arcadia pergone.....	119
Armierungsdistanzhalter.....	149
Armierungseisen.....	148
Armierungsnetze.....	148
Armofer Lagerfugenarmierung.....	144
Asphalt-Reparaturmörtel.....	148
Aussaaterde.....	106

B

Backsteine.....	142
Bambussperre.....	177
Bändchengewebe.....	195
Bank.....	84
Barrafil.....	129
Baugips.....	130
Bauguss.....	154
Baukleber.....	129
Baumverankerung.....	115
Bauplastik.....	193
Bauplatten.....	139
Bauschutzmatten.....	181
Bedachungsmaterial.....	179
Beeteinfassung Rite Edge.....	67
Befestigungstechnik.....	192
Begu-Deckel.....	154
Benzin.....	202
Beton.....	125
Betonbretter.....	67
Betondeckel.....	154

Betonklebbänder.....	196
Betonpalisaden.....	74
Betonplatten.....	7
Betonrohre.....	151
Betonrundeisen.....	148
Betonstellriemen.....	65
Betonstürze.....	143
Bewehrungsanschluss.....	149
Big-Bag.....	147
Bio-Rasendünger.....	112
Bitumen.....	179
Bitumen-Dichtungsbahnen.....	179
Bitumenlack.....	180
Blachen.....	195
Blähton.....	107 141
Blockstufen.....	63
Blumenerde.....	106
Blumentröge rechteckig.....	76
Bodenabläufe.....	154
Bodenschutz.....	62 193
Bodenschutzplatten.....	62
Bordsteine.....	67
Böschungsmatten.....	177
Böschungssteine.....	70
Bretter.....	93 184
Brunnenschäum.....	141
Brunnröge.....	76
Bundsteine.....	67
Buttholz.....	184
Buttholz-Schaltafeln.....	184

C

Camping-Gas.....	201
CD-Deckenprofile.....	146
Cermix.....	133
Certoplant.....	112
Chromstahlbriden.....	172
Container.....	201
Containernischen.....	121 122

D

Dachlatten.....	184
Dachpappen.....	179
Dachpappenstifte.....	192
Dachrinnenschlauch.....	195
Dachschindeln.....	181
Dampfbremsen.....	189
Delta Floraxx.....	41
Delta MS.....	41
Delta Terraxx.....	41
Diagonalgeflecht.....	98
Dichtbänder.....	190
Dichtzäune.....	94
Dickbeschichtung.....	130
Distanzhalter «Raschal».....	150
Distanzrohre.....	150

Distanz- und Bewehrungskörbe 149
 Doppellatten 184
 Doppel-T-Verbundsteine 42
 Draht 97
 Drahtbinder 149
 Drahtgeflechte 98
 Drahtspanner 97
 Drainageprodukte 39
 Drainflex-Drainagerohre 173
 Drankiesleisten 69
 Dreh-Stelzlager 36
 Dreikantleisten 184
 Druckimprägnierte Bretter 93
 Druckimprägnierte Pfähle 90

E

EcoCrete 125
 Eichenkübel 86
 Eichenschwellen 93
 Eisenwaren 97
 Elektroerohre 174
 Emulsion 180
 Entkoppelungsplatten 141
 Entwässerungs-Rinnen 159
 EPS 185
 Estrichbeton 125
 Eternit Möbel 84
 Eternit - Schachtfutter 172
 EverBag 87

F

Fallschutzplatten 37 39
 Fassadenbahn 190
 Feinsteinzeugplatten 19 21
 Feinsteinzeugplatten Aussen 19 21
 Fermacell-Platten 145
 Fertigbeton 125
 Filtergewebe 175
 Filzüberziehpantoffeln 203
 Fire Foam 141
 Flächendrainage 39
 Flachrinne 162
 Flaga propangas 201
 Flaschendeput 201
 Flexfliesenkleber 133
 Floorliner 196
 Floraxx 40 H 41
 Fortal Leitern 199
 Fugendichtungsmasse 136
 Fugenfüllprofile 137
 Fugenkreuze 31
 Fugenmörtel 135
 Fugensand 136
 Fumor kompostierter Mist 106

Fundament 63

G

Gabionen 116
 Garnitur 86
 Gartenholz-Sortiment 90
 Gartenkies 148
 Gartenkiesfixierung 62
 Gartenkompost 106
 Gartenplatten 7
 Garten-/Terrassenplatten 11 14 16 17 18
 Gasbetonsteine 143
 Gas Propan 201
 Gehwegplatten 7 9
 Geofiltergewebe 175
 Geotextilien 175
 Geranienerde 106
 Gerüstbretter 184
 Gewebeplanen 195
 Giessring 116
 Gips 130
 Gipskartonplatten 145
 Gipsplatten 184
 Gipsplatten 144
 Gipsplattenkleber 130
 Gitterroste 153 154 158 167 197
 Gitterrosticherungen 158
 Glasfasergewebe 146
 Glaswolle 188 189
 Gleitmittel zu PVC-Rohren 173
 Granol-Produkte 130
 Grasprotecta 62
 Grundierungen 132 133
 Gummigranulatmatten 181
 Gummipplatten 37
 Gussdeckel 155
 Guss-Schlitzrost 167
 Gutjahr Produkte 39

H

Halbrundlatten 93
 Halbschalen-Gitterroste 153
 Handschuhe 203
 Hartfaserplatten 184
 Hauer Dünger 113
 Hochbeet 119
 Holzdreikantleisten 184
 Holz/Hobelwaren 184
 Holzpalisaden 91
 Holzschnitzel 106

I

Ice-Remover 147
 Isolationen 185
 Isolierband 196

Isover 188

J

Jutegerwebe 177

K

Kabelschutzrohre 174
 Kalksandsteine 143
 Kaltbelag 148
 Kanalisationsrohre PVC/PP/PE 170
 Kanthölzer 184
 Kapsel-Gehörschutz 203
 Kehrlicht-Container 201
 Kiesbinder 62
 Kiesring 168
 Kiesstabilisierer Stonefix 62
 Klebebänder 196
 Kleinpflaster 53
 Klinker 57
 Knauf 130 146 188
 Knauf Profile & Zubehör 145
 Knotengitter 98
 Kokosgewebe 177
 kompostierter Mist 106
 Kosmetikmörtel 129
 Kranarbeiten 204
 Kunststoff-Distanzrohre 150

L

Ladeschienen 199
 Landerde 107
 Lärchenrinde 106
 Lastwagen 204
 Latten 184
 Lichtschacht-Aufhängungen 158
 Lichtschächte 157
 Lichtschacht-Gitterroste 158
 Lieferbedingungen 206
 Liege 86
 LightCrete 125
 Lithofin-Reinigungsprodukte 132
 L-Steine 70
 L-Tec light 73
 L-Tec Winkelplatten 73

M

Majpell/Majcoat 190
 Malerfolie 193
 Mapei-Produkte 125 126 129 130 132 133
 135 139 141 186
 Massimo Grossformatplatten 15
 Massivbauplatten 145

Mauermörtel 126
 Mauerscheiben 73
 Mauerwerksbewehrung 144
 Misapor 147
 Montageschaum 141
 Multi Adhesive Foam 141
 Multipor 187
 Multiseal 130

N

Nägel 192
 Nanocrete 129
 Natursteinfugen 136
 Natursteinkleber 136
 Nivelliermassen 127
 Novoment 125
 Nypondübel 192

O

Oberflächenschutz 11
 Oeko Bauplastik 193
 Oeko Drain 59
 Onduline Bitumen-Wellplatten 181
 OSB-Verlegeplatten 184

P

Paletten Infos 205
 Palisaden 74 91
 Palisadenwandbretter 67
 Pasand Platten 12
 Pavatex 184
 PCI Grundierungen und Anstriche 132
 PE-Kanalisationsrohre 170
 Pergonen 118
 Perimeterkleber 130
 Perifix 130
 Pfähle 90
 Pflanzenperlite 106
 Pflastersteine 42
 Piazza Pflastersteine 51
 Planen/Plastikfolien 193
 Plattenkleber Gips 130
 Plattenlager 32 33
 Platten mit Oberflächenschutz 11
 Poller 70
 Polygonal-Pflaster 53
 Polystyrol-Hartschaumplatten 185
 PP-Kanalisationsrohre 170
 Primer 132 137
 Profix 146
 Propangas 201
 PU-2K-Rapidschaum 141
 PVC-Kanalisationsrohre 170

Q

Quarzsand 148
 Querkraftdorn 149

R

Rand Einfassungen 68 69
 Randsteine 67
 Randstellstreifen 186
 Rankgitter 94 97
 Rasenerde 106
 Rasengittersteine 59
 Rasenkantensteine 69
 Rasenliner 59
 Rasensamen 109
 Rasen-/Splittfugensteine 59
 Rasenwaben 62
 Rechtecksteine 42
 Reduktionen 171
 Regenjacke 203
 Regenwassernutzung 122
 Reparaturmörtel 126 127 129
 ReRoot 177
 Revisions Einbautüren 197
 Rhizomsperr 177
 Ricoter Erden 106
 Rinnen 159
 Rite-Edge 67
 Rohrpfosten 100 102 104
 Rohrstreben 102
 Rohrtraversen 102
 Rollrasen 111

S

Sakret 62 137 148
 Sammler 151
 Sandgestrahlte Platten 8
 Sand/Kies 147
 Schachtboden 152
 Schachtfutter 172
 Schachtleitern 158
 Schalbretter 184
 Schaltafeln 184
 Schalungssteine 144
 Schalungszubehör «Albanese» 150
 Schilfrohmatten 95
 Schlemmsand 147
 Schlitz-/Verfüllmörtel 126
 Schnellbauschrauben 146
 Schuhkratz-Gitterroste 197
 Schutzhandschuhe Showa 203
 Schutz- und Abdeckvlies 196
 Schutz- und Trennvlies 175
 Sechseckgeflecht 99
 Sichtbetonqualität 73

Sichtschutz 88 94 95 106 107 109 111 112 113
 Sickerkies 147
 Sicker-Pflastersteine 45 47 59
 SIGA-Produkte 190
 Sika-Produkte 129
 Silikon 137
 Sitzbank 84
 Sparrenrollen 189
 Spartana-Antik-Pflastersteine 51
 Spielsand 147
 Splitt 147
 Stacheldraht 97
 Stahlton 142
 Ständerprofile 146
 Staubschutzmasken 203
 Stegrost 164
 Steifix-Randabschlussprofil 63
 Steingitterkörbe 118
 Steinwolle-Isolierprodukte 187
 Stellriemen 65
 Stelzlager 35
 Stifte 192
 Strassensammler 151
 Stufendrainage 39
 Sturz-Bretter 142
 Swiss-Modul-Backsteine 142
 Swisspearl-Pflanzgefäße 78
 Swisspor 179 180 181 185 186 187
 System N20 Platten 28
 Sytecdrain 41
 Sytec-Produkte 62 116 175

T

Tauchbogen 171
 Teichfolien 89
 Teppichband 196
 Terracotta Gefäße 87
 Terrassenplatten 11
 Terrax 41
 Thumaphon 141
 Thumasole blu 196
 Tonsturz-Bretter 142
 Torf 107
 Trasszement 125
 Trenn- und Filtervlies 175
 Trittschallplatten 141
 Trockenbeton 125

U

Überschiebemuffen 172
 Überzugsmörtel 125
 Uniflott 130
 Universalerde 106

Unkrauthemmvlies 175
 Unterlagsbodennetze 148
 U-Steine 70

V

Vandex-Betonbauschlämme 130
 Vegano Royal Bio Dünger 112
 Ventilationseinsätze 197
 Verbundplatten 19
 Verbundsteine 58
 Vergussmörtel 127
 Vierkantpfosten 91
 Vlies 175
 Vollgipsplatten 144
 VonRoll Bauguss 155

W

Wannenelemente 139
 Wartenberg 54
 Waschbetonplatten 7
 Wassertrog 76
 Watec 39
 Wedi 139
 Weedguard 177
 Weidenmatten 95
 Weissputz 130
 Wellbleche 182
 Wellpolyester-Dachplatten 181
 Wildblumenmischungen 110
 Wildenstein 53
 Winddichtung/Fassadenbahn 190
 Winkelplatten 70
 Winkelprofile 168
 Wood Mood Platten 29
 Wurzelballenverankerung 115
 Wurzelbelüftung 115
 Wurzelbewässerung 114
 Wurzelschutzvlies 177
 Wurzelsperre 177

X

XPS Isolierplatten 185

Y

Ytong Gasbetonsteine 143
 Ytong-Kleber 126
 Ytong Multipor 187
 Ytong Planblockmörtel 143

Z

Zaunriegel 93
 Zauntore 103
 Zement 125
 Zement-Kalk-Putz 126
 Zementmauermörtel 126
 Zementplatten 7
 Zementrohre 151
 Zementrohre mit Boden 151
 Zementrohr-Halbschalen 153
 Zementrohr-Konen 153
 Zementsand 147
 Zement-Sockelputz 126
 Zement-Unterlagsplättli 150
 Zwischenwandplatten 142

BAUMATERIAL SPÄTH

Bau- und Gartenbedarf

seit 1969

PREISLISTE 2024



Falkensteinerstrasse 13
4132 MuttENZ
kontakt@baumaterial-spaeth.ch

Unsere Öffnungszeiten

Sommer 1. März bis 31. Oktober
Montag – Freitag **06.45 – 17.00 Uhr** (durchgehend)

Winter 1. November bis 28. Februar
Montag – Freitag **07.15 – 17.00 Uhr** (durchgehend)



061 641 13 51



www.spaeth-shop.ch

gedruckt in der
schweiz